

**HORIZONTAL SLAT SCREENING  
VARIABLE SLAT & SPACING PANEL  
QUICKSCREEN POST SYSTEM**

**INSTALLATION  
OVERVIEW**

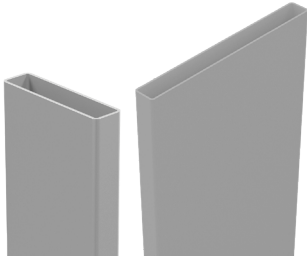

**2.56" Slat or 6" Slat**

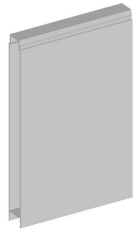

**Full Privacy 6" Slat**

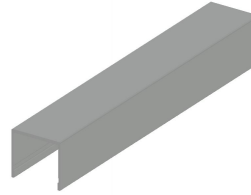

**Privacy slat finishing trim**

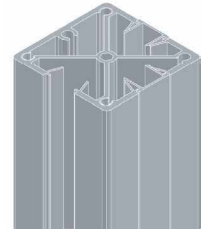

**One way post**

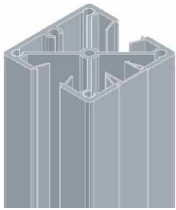

**Two way post**

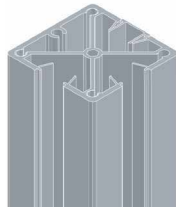

**Corner Post**

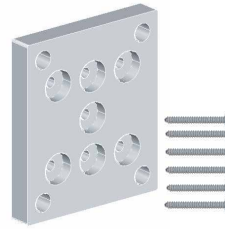

**Base plate with screws**



**Post top plate**

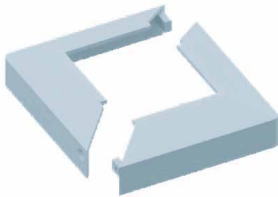

**Domical cover**



**3/8" spacer block**



**1/2" Spacer block**



**1" Spacer block**



**Setting spacer pre-fitted to every post**

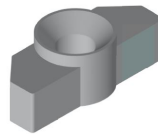

**Slat Clip**

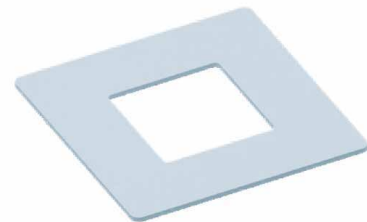

**Dress ring**

**OPTIONAL EXTRAS:**



**Centre Support Rail**



**Centre Support Rail Top Cap**



**Wafer screws**

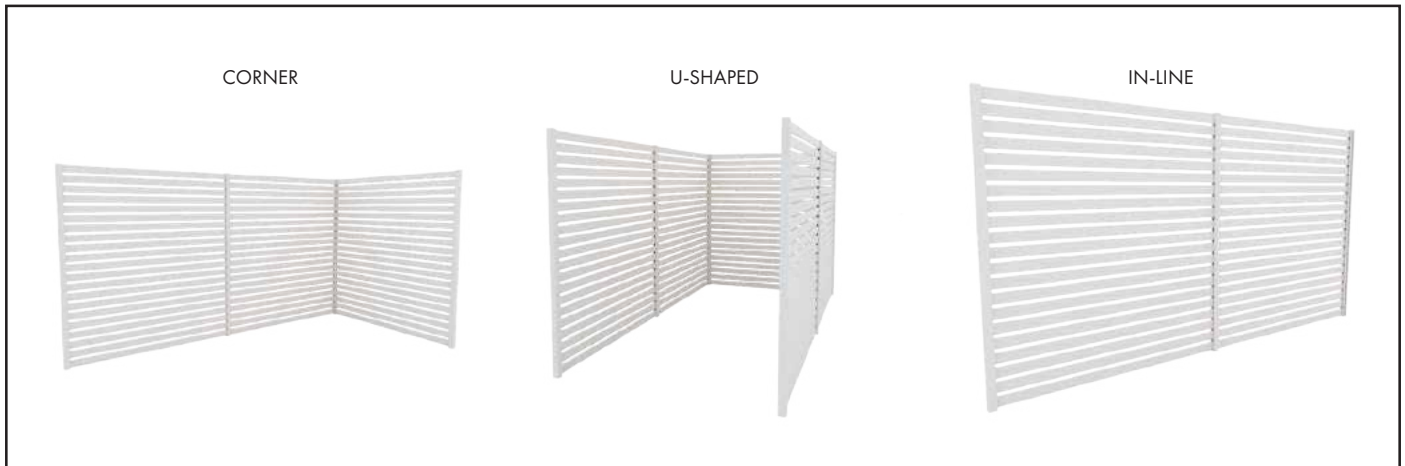

**1** Determine fence layout



**2** Determine how posts are to be installed:

1. Core drill into concrete (recommended min  $\varnothing$  2 1/2" core hole at approx. 4 inches deep)

2. Base plated to surface (for high wind areas, refer to attached engineering specs)

3. Set into ground with concrete footings, making sure local building codes are followed. (refer to attached engineering specs)

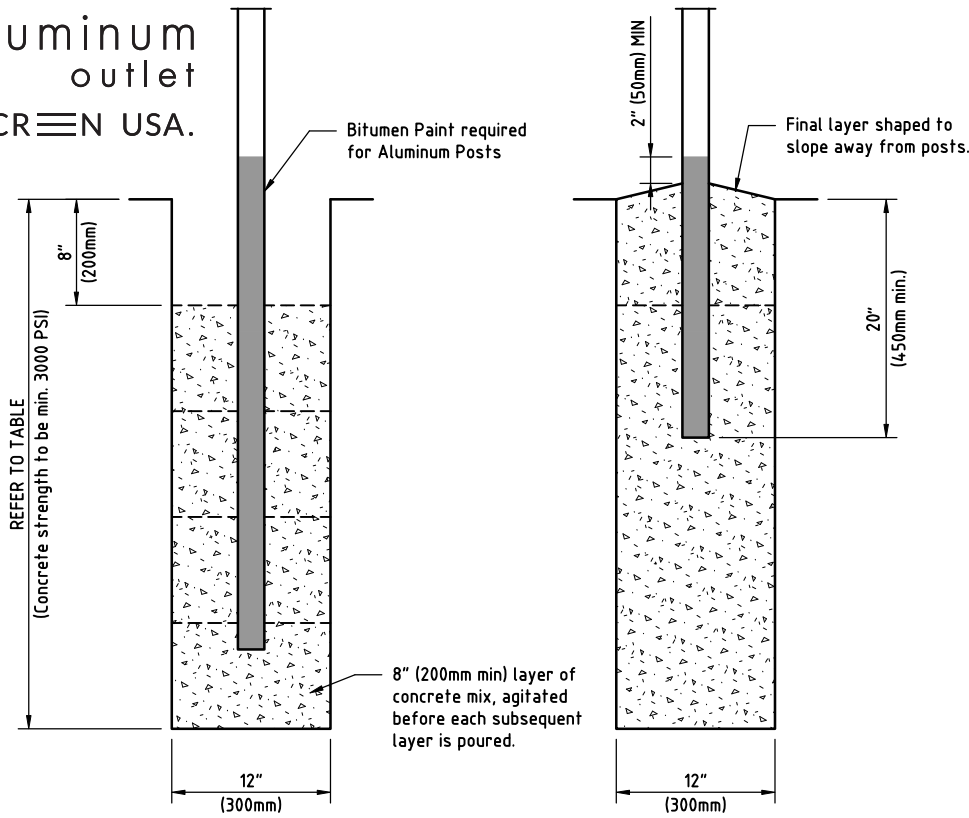

**POST CAST INTO FOOTING DETAIL**

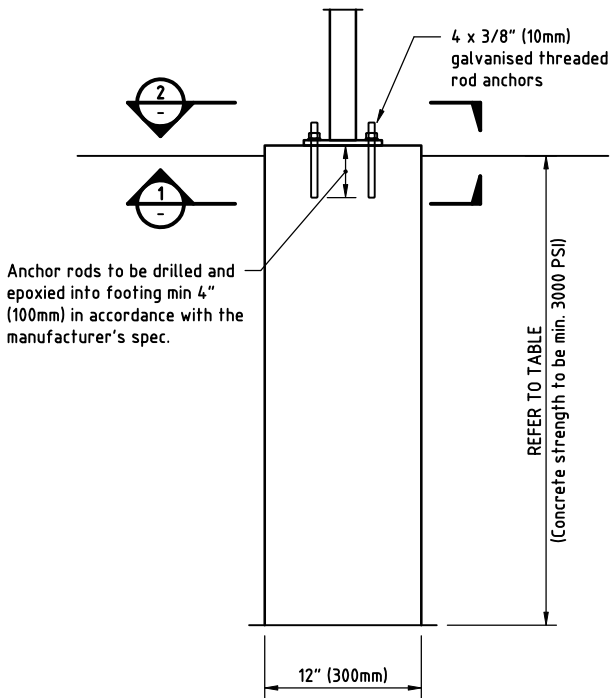

**POST INSTALLED ON TOP OF FOOTING DETAIL**

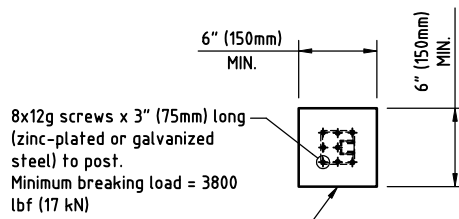

**SECTION 1**  
SCALE 1:10

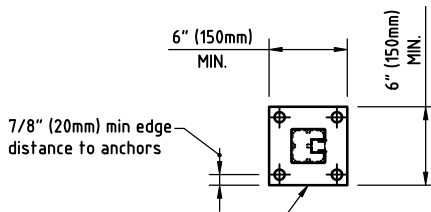

**SECTION 2**  
SCALE 1:10

MINIMUM FOOTING DEPTHS (inches) - 12" DIA PIER			
SOIL TYPE	CAST IN POST	CAST IN POST	POST BOLTED TO FOOTING
	6063-T6 ALLOY	6005-T5 ALLOY	MINIMUM 6063-T6 ALLOY
SAND ( $\phi=25$ DEG)	40	44	32
SAND ( $\phi=30$ DEG)	36	40	30
SAND ( $\phi=35$ DEG)	32	36	28
SANDY CLAY ( $\phi=25$ DEG, $c=3.5$ psi)	40	44	32
STIFF CLAY ( $\phi=15$ DEG, $c=5.0$ psi)	36	40	30

Each anchor must resist a pullout force (LFRD) of 3300 lbf (15 kN)

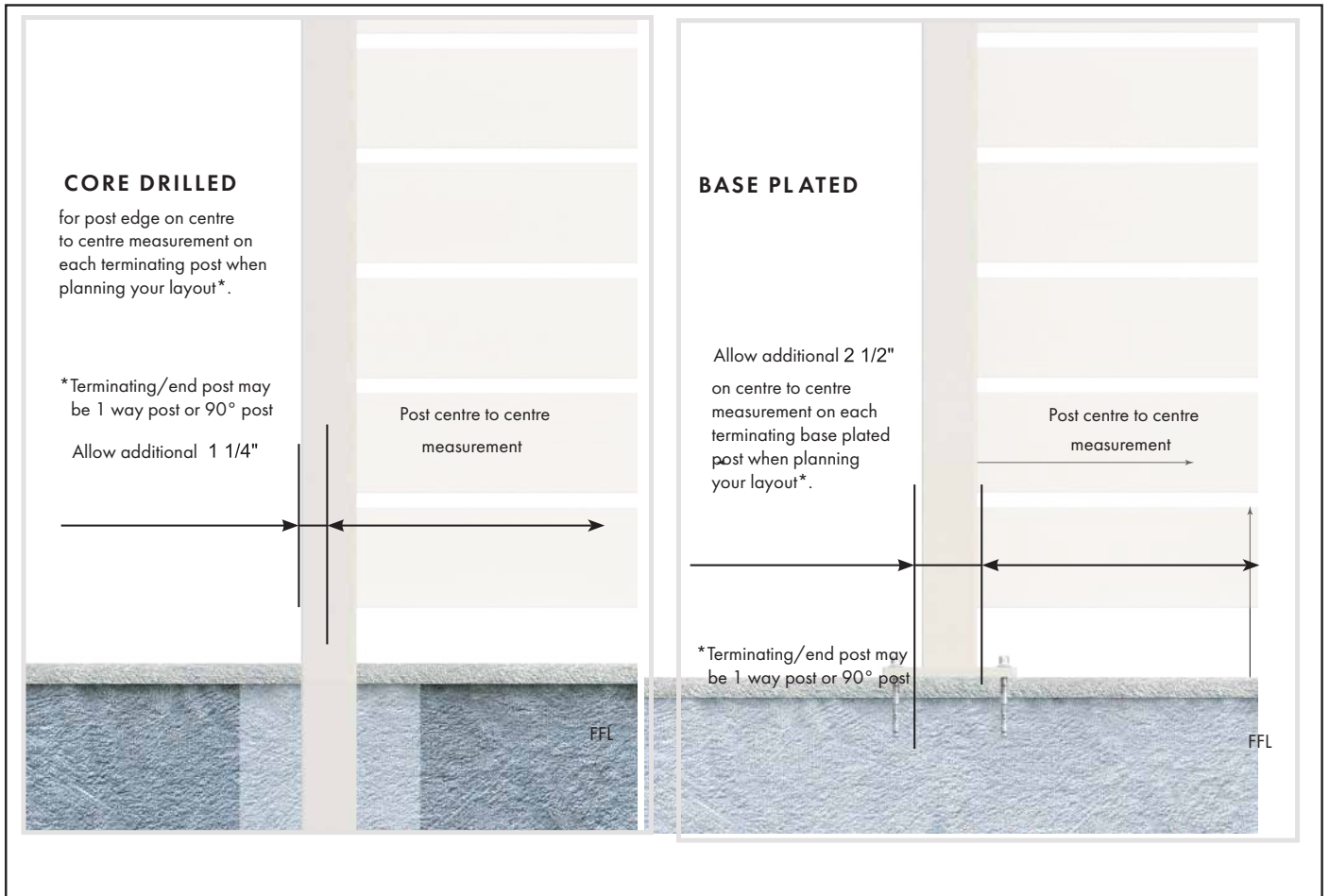

- 3** Determine post positions. For simplicity, calculate post positions from centre of post to centre of post. Recommended that post centres do not exceed , in areas of high wind, consider restricted span widths.

Install tip: For end of corner posts of a run, there will be 1 1/4" extra to take into account for 'overhang' of 2 1/2" post.

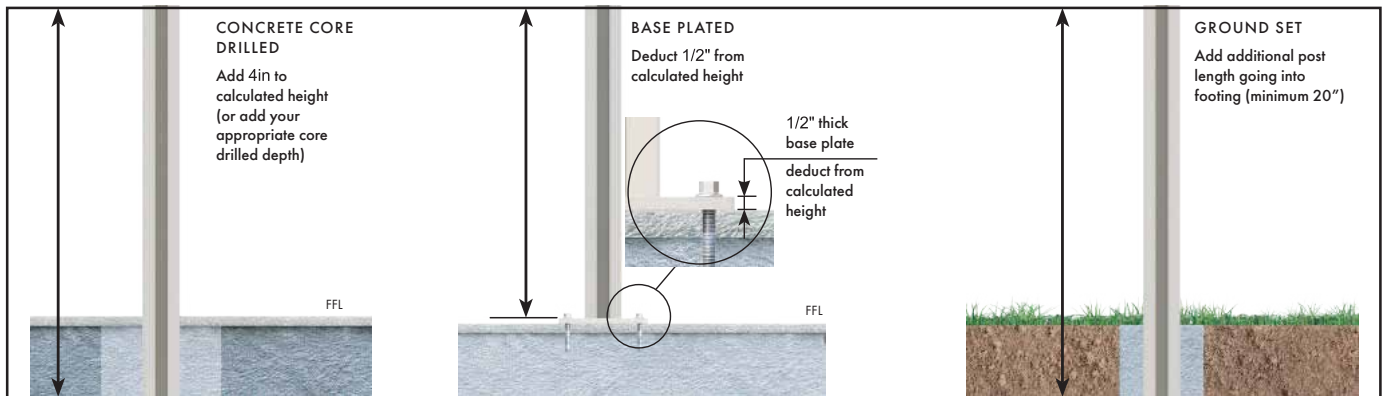

**4** Determine overall post height required.

For overall post heights required, add the extra length below the surface for core drill and concrete footings.

For base plated installations, deduct 1/2" from screen height (as base plate is 1/2" thick).

Install posts.

TIP - Use spirit level to ensure posts are vertically level. Ensure top of posts level and in alignment.



**5** NOTE: For uneven ground, determine height wanted (e.g. 2 inches), and place first post and last post in the run. Then, connect a string line to the two posts at the height of the starting blocks and adjust the height of the first or last post until the string line is level, ensuring posts are plumb in all directions. Cement the two posts into place. Place remaining posts in the run and adjust height so that starting blocks line up with the string line. Plumb the posts and cement into place.

FOR CORE DRILLED applications, remove the starting blocks and cut to desired length (core drill depth + clearance). Follow the procedure outlined above to complete the installation.

FOR BASE PLATE fixing, remove the starting blocks from the posts and cut one to length for the first post. Fit the base plate and install into place. Install the last post WITHOUT the starting block and run a stringline across the top of the posts. Where a post sits above the level string line, mark and cut the post so that the first and last post are level. At every post interval, measure from the string-line to the floor. Subtract 1/2 inch (base plate thickness) from this measurement and cut the post. Attach all base plates to the posts and fix to the floor. Set a level string line between 1st and last posts. Starting from the top of starting block on 1st post, measure from the top of the base plate to the string line on all remaining posts and cut the starting blocks and fit into place. NOTE: For necessary post heights, refer to attached post height chart.

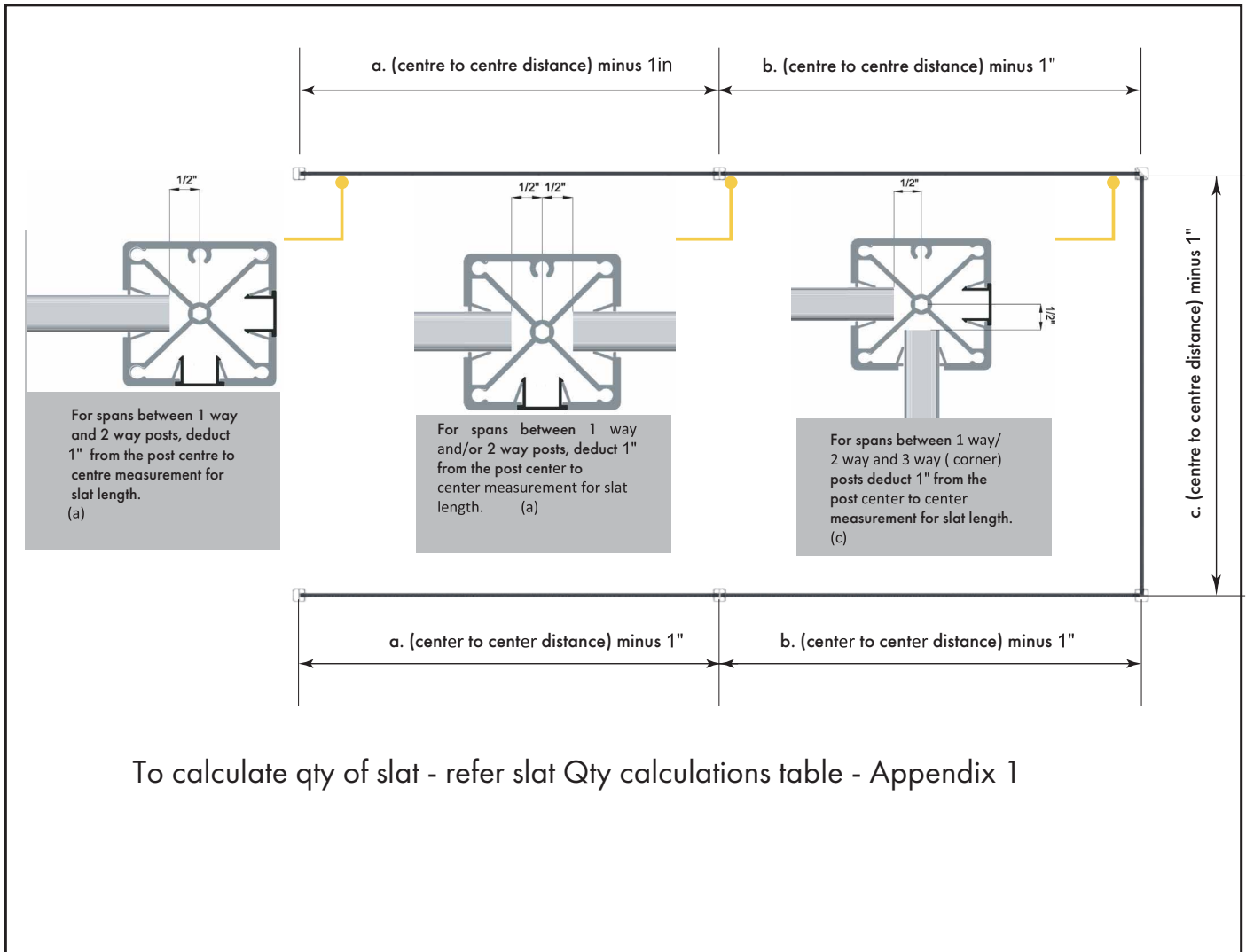

6

- a. For spans between any 1 way post and 2 way post combination, slats are cut **1" less** than the center to center of posts.
- b. For spans leading into a 90 degree post, slats are cut **1" less** than the center to center of posts.
- c. For spans between two 90 degree posts, slats are cut **1" less** than the center to center of posts.

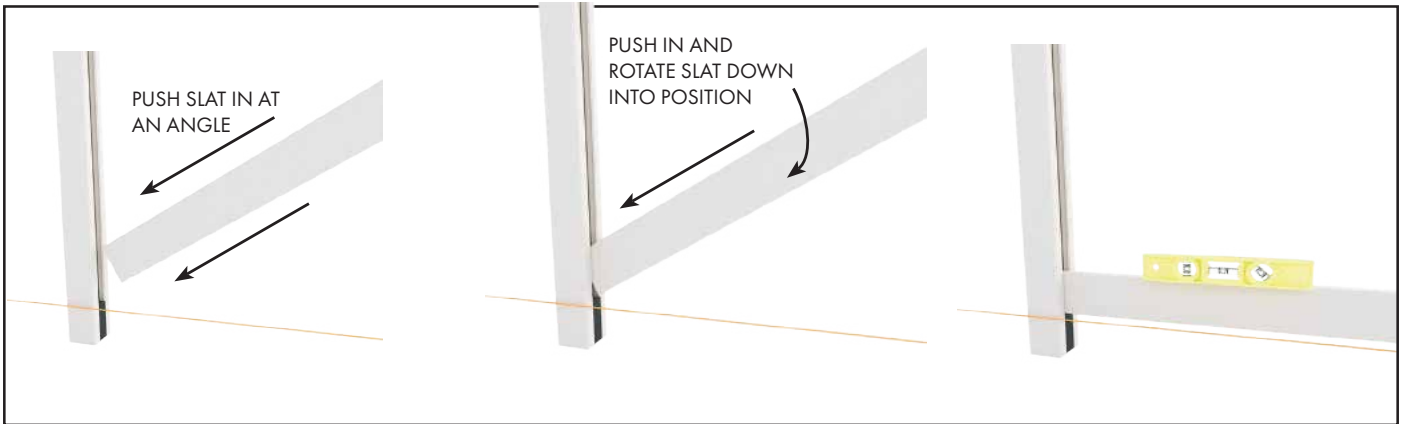

**7** Install first slat in each span. Using spirit level, ensure slats are level.

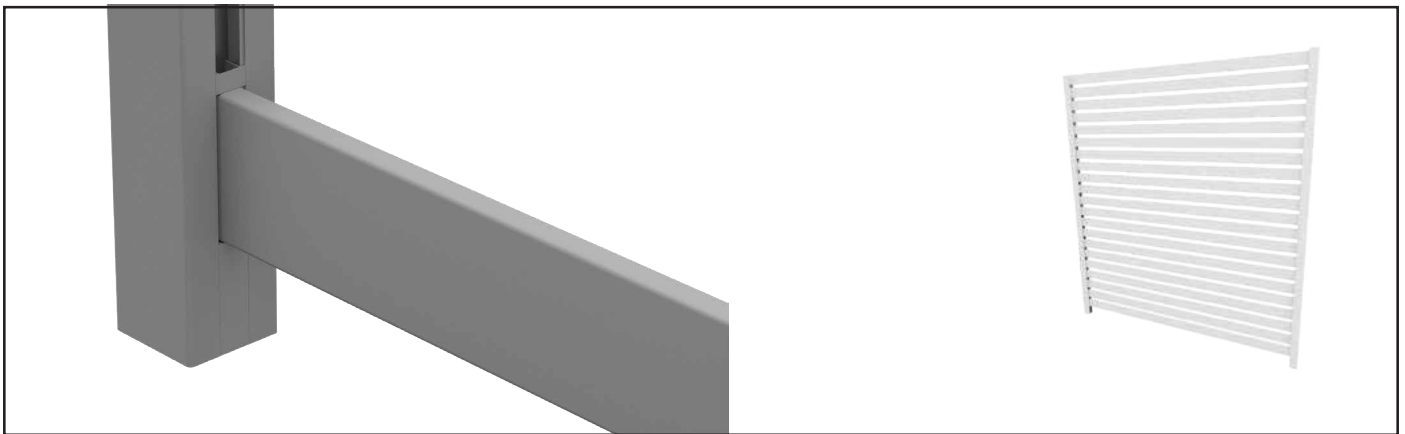

**8** Snap in spacer block above first slat into either side of pocket of post. Repeat for all slats.

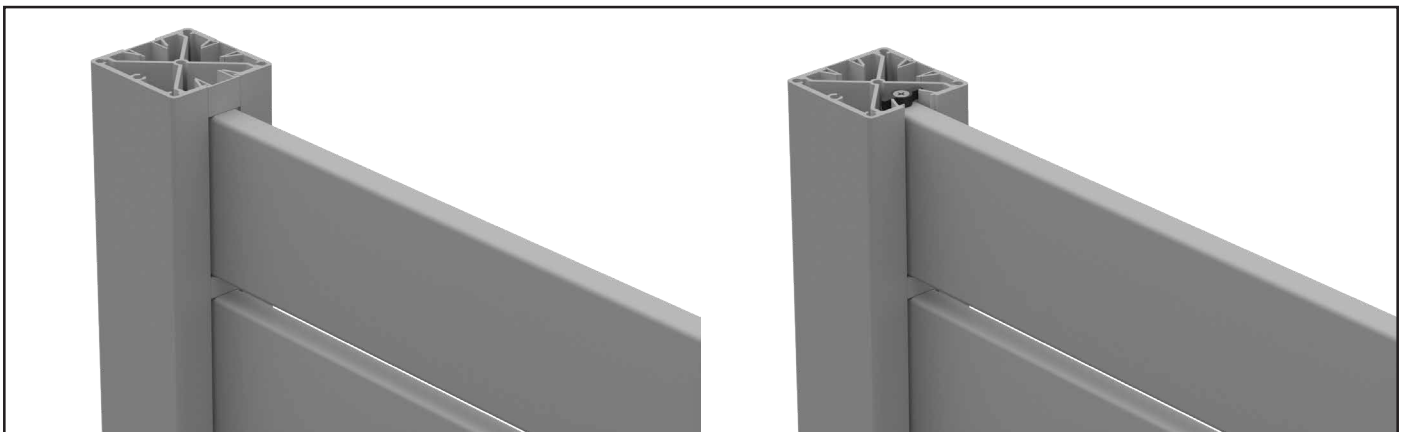

**9** Top slat finishes 3/8" below the top of the post. Alternatively use slat spacer on top slat.

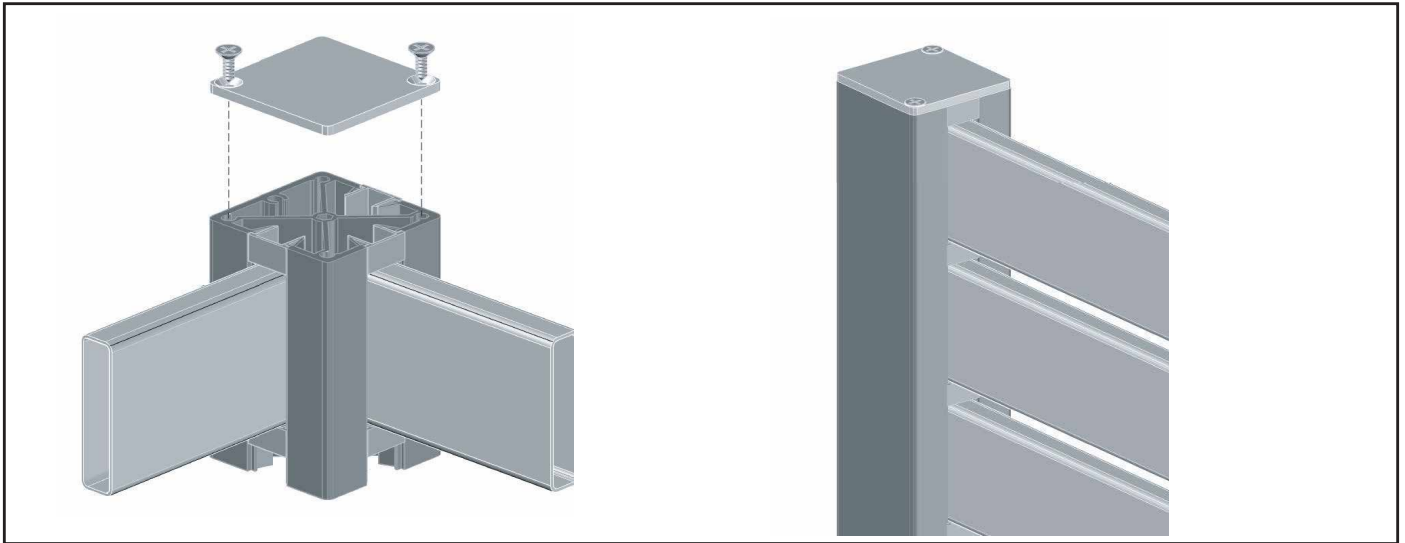

**10** Finish with or without spacer block above slat or **slat clip** and install top plate with supplied screws.

**IMPORTANT:** A slat clip is to be used on the last slat at the top of the post, when the post is used to carry the hinges of an attached gate. This is to prevent the post from bending from the weight of the gate.

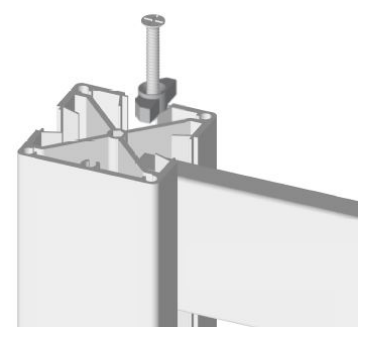

OPTIONAL  
EXTRA:  
**Centre  
support  
rail**

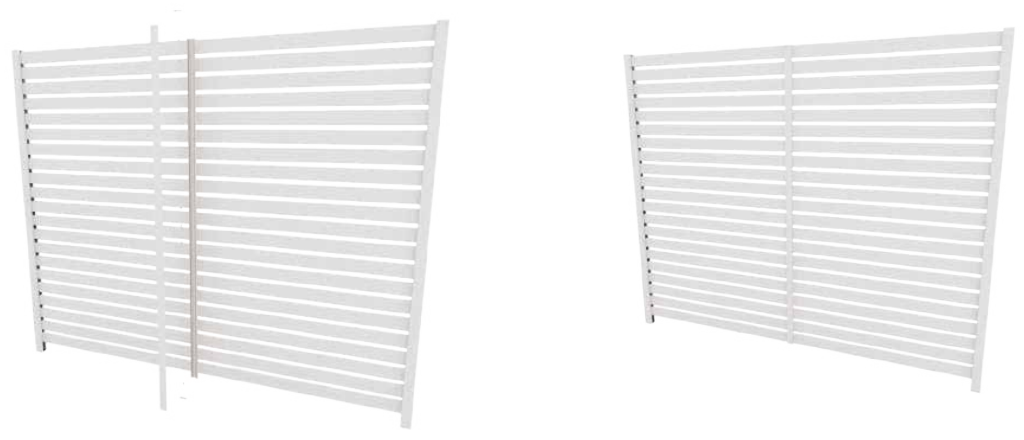
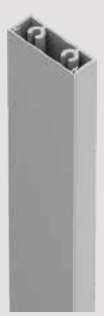

**11**

**Install note: Optional: For spans in high wind areas it is recommended to have a centre support rail.**

Place centre support rail against slats and screw off at each slat using wafer screws. Snap on fixing cover to hide screws, and apply the centre support rail top cap.





**2.56" slat spacing table**

- 1 **Ht of post** - Total height from ground to top of post (incl. top cap)
- 2 **Slat Qty** - Total number of slats required for height shown in corresponding rows. 2.56" slat sold in 2 packs.  
**Slat spacing** - Height of gap between each slat  
**Ht from bottom of 1st slat to top of last slat** - Height shown
- 3 includes spacers.
- 4 - Bottom slat: sits on top of end plate if using side frame. If using post system slat sits on top of starting block which you control the height of (you adjust this to meet overall height taking into consideration slopes and alignment of other panels)  
· Top slat: No spacer is generally used unless you need to fill post due to gap above slat

Overall screen height does not include any gaps below or above slat panel. It does take into consideration extrusion tolerances. Due to tolerance variations, you may need a spacer at top of panel to fill void.

Slat calculation formula = height / ((slat size + slat spacing) - spacing)

Always round down number to next lowest full slat EG 10.35 - qty of slat 10

Remaining portion slat you allow for in positioning of side frame on post or with friction fit post build fraction into starting block.



**6" slat spacing table**

- 1 **Ht of post** - Total height from ground to top of post (incl. top cap)
- 2 **Slat Qty** - Total number of slats required for height shown in corresponding rows. 2.56" slat sold in 2 packs.  
**Slat spacing** - Height of gap between each slat  
**Ht from bottom of 1st slat to top of last slat** - Height shown
- 3 includes spacers.
- 4 - Bottom slat: sits on top of end plate if using side frame. If using post system slat sits on top of starting block which you control the height of (you adjust this to meet overall height taking into consideration slopes and alignment of other panels)  
· Top slat: No spacer is generally used unless you need to fill post due to gap above slat

Overall screen height does not include any gaps below or above slat panel. It does take into consideration extrusion tolerances. Due to tolerance variations, you may need a spacer at top of panel to fill void.

Slat calculation formula = height / ((slat size + slat spacing) - spacing)

Always round down number to next lowest full slat EG 10.35 - qty of slat 10

Remaining portion slat you allow for in positioning of side frame on post or with friction fit post build fraction into starting block.

**APPENDIX 1**

2 9/16" (65 mm) Slat			
1. HT OF POST	2. SLAT QTY.	3. SLAT SPACING	4. HT FROM BOTTOM OF 1ST SLAT TO TOP OF LAST SLAT
3'	14	Nil	36"
	12	3/8" (9mm)	35 1/4"
	11	1/2" (12.7mm)	33 7/8"
	10	1" (25.4mm)	35 3/4"
4'	18	Nil	46 3/8"
	16	3/8"	47"
	15	1/2"	46"
	13	1"	46 15/32"
5'	23	Nil	59 1/4"
	20	3/8"	58 3/4"
	19	1/2"	58 9/32"
6'	16	1"	57 3/16"
	28	Nil	72"
	24	3/8"	70 1/2"
	23	1/2"	70 17/32"
7'	20	1"	71 1/2"
	32	Nil	82 13/32"
	28	3/8"	82 1/4"
	27	1/2"	82 11/16"
8'	23	1"	82 1/4"
	36	Nil	92 5/8"
	31	3/8"	91 1/16"
	30	1/2"	92"
	26	1"	93"

6" (150 mm) Slat			
1. HT OF POST	2. SLAT QTY.	3. SLAT SPACING	4. HT FROM BOTTOM OF 1ST SLAT TO TOP OF LAST SLAT
3'	6	Nil	36"
	5	3/8"(9mm)	32 5/32"
	5	1/2"(12.7mm)	31 15/32"
	5	1"(25.4mm)	34 11/16"
4'	8	Nil	48"
	7	3/8"	45"
	7	1/2"	44 1/32"
5'	6	1"	41 5/8"
	10	Nil	50"
	9	3/8"	57 7/8"
	9	1/2"	56 5/8"
6'	8	1"	59"
	12	Nil	71 1/4"
	11	3/8"	70 3/4"
	11	1/2"	69 7/32"
7'	10	1"	69 3/8"
	14	Nil	83"
	13	3/8"	83 9/16"
	13	1/2"	81 13/32"
8'	12	1"	83 1/4"
	15	Nil	89 1/16"
	14	3/8"	91 1/16"
	14	1/2"	88 1/16"
	13	1"	90 3/16"

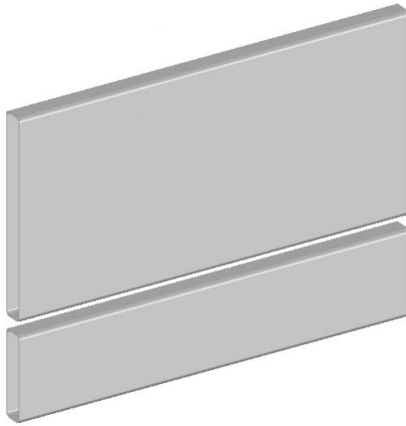

## APPENDIX 2

COMINATION ( 2 9/16" + 6" Slats)				
1. HT OF POST	2. SLAT QTY.		3. SLAT SPACING	4 HT. FROM BOTTOM OF 1ST SLAT TO TOP OF LAST SLAT
	2 9/16"	6"		
3'	4	3	3/8"	30 1/8"
	4	3	1/2"	31"
	4	3	1"	34"
4'	5	5	3/8"	45 1/2"
	5	4	1/2"	40 1/2"
	5	4	1"	44 7/32"
5'	7	6	3/8"	57 5/8"
	6	6	1/2"	56 1/4"
	6	5	1"	54 7/8"
6'	8	7	3/8"	66 3/4"
	8	7	1/2"	68 7/8"
	7	6	1"	65 3/8"
7'	9	9	3/8"	82 1/4"
	9	8	1/2"	78 5/32"
	8	9	1"	82 3/4"
8'	10	10	3/8"	91 3/8"
	10	10	1/2"	94 1/8"
	9	9	1"	93 1/8"

### 2 9/16" and 6" slat - Combination spacing table

Ht of Post - Total height from ground to top of the post ( incl top cap) Slat Qty - Total number of slats required for height shown in corresponding rows.

Slat spacing - Height of gap between each slat

Ht from bottom of 1st slat to top of last slat- Height shown Includes spacers

Bottom slat : sits on top of end plate if using side frame. If using post system, slat sits on top of starting block, which you control the height of. (You adjust this to meet overall height, taking into consideration slopes and alignment of other panels)

Top slat: No spacer is generally used unless you need to fill post due to gap above slat

Overall screen height does not include any gaps below or above slat panel. It does take into consideration extrusion tolerances.

Due to tolerance variations, you may need a spacer at the top of the panel to fill void

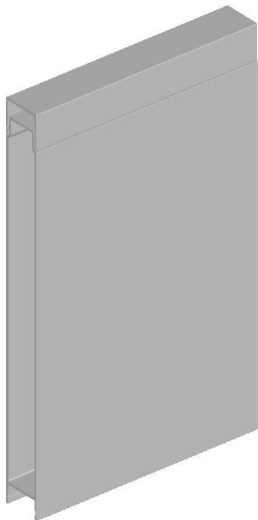
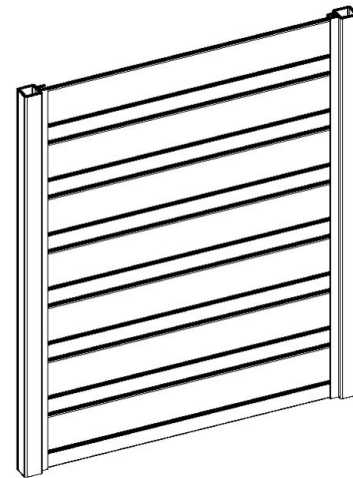

6" Privacy slat		
1. HT OF POST	2. SLAT QTY	4. Ht. from Bottom of 1st Slat to Top of Last Slat
3'	6	35 21/32"
4'	8	47 1/2"
5'	10	59 1/2"
6'	12	71 5/8"
7'	14	63 1/4"
8'	16	95 1/8"

### 6" slat - Full privacy spacing table

Ht of Post - Total height from ground to top of the post ( incl top cap)

Slat Qty - Total number of slats required for height shown in corresponding rows.

Ht from bottom of 1st slat to top of last slat-

Bottom slat : sits on top of end plate if using side frame. If using post system, slat sits on top of starting block, which you control the height of. (You adjust this to meet overall height, taking into consideration slopes and alignment of other panels)

Top slat: No spacer is generally used unless you need to fill post due to gap above slat

Overall screen height does not include any gaps below or above slat panel. It does take into consideration extrusion tolerances.

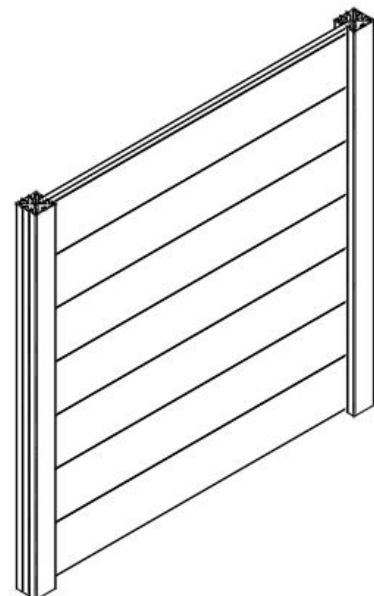

## APPENDIX 3 HIGH WIND SITUATIONS

If using 1 or 2 way posts, orient top cap with 2 holes over the slats and screw off top cap into slats.

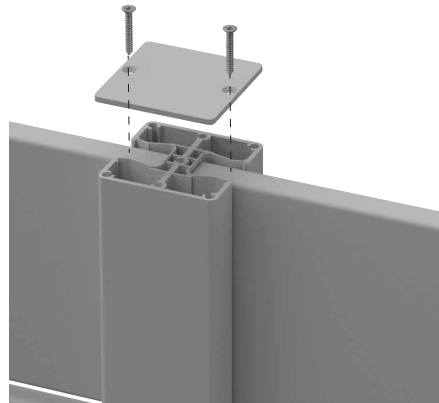
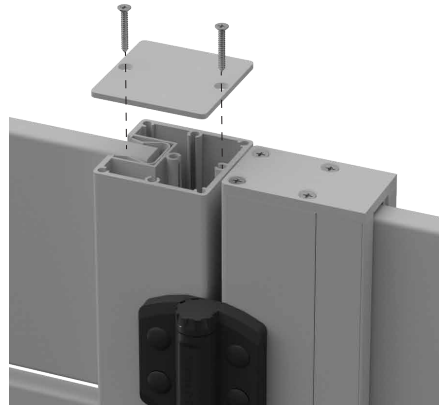

If using 3 way post, ensure there is sufficient space at top of post. Prior to attaching top cap, attach a slat clip to top of top slat.

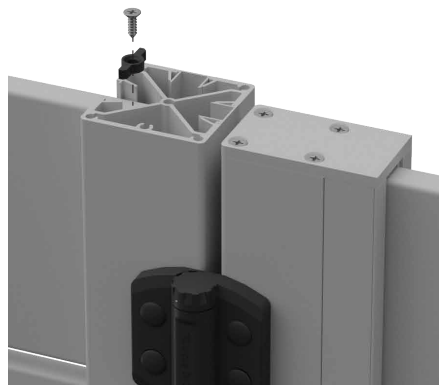

## APPENDIX 4

### ATTACHING POST TO MASONRY

1. PREDRILL THROUGH THE CENTER SCREW FLUTE, A 5/16" HOLE FOR EACH SCREW, 3 HOLES FOR 3' AND 4' POSTS AND 4 SCREWS FOR OVER 4'. 1st AND LAST HOLES ARE DRILLED 4" FROM EACH END, AND THE REMAINDER EQUALLY SPACED.
2. POSITION THE POST AT THE REQUIRED POSITION AND MARK THE HOLE POSITION ON THE WALL..
3. THROUGH THE MARK, DRILL 5/16" HOLES.
4. ATTACH THE POST TO THE WALL USING CONCRETE ANCHOR SCREWS.

