

HIGHEST QUALITY  
LOWEST PRICES

DISTRIBUTORS &  
RESELLERS ONLY

# QUICK SCREEN™ slat fencing system

## What you'll find inside

---

Quickscreen Horizontal Slat Fencing - Page 2 – 17

Quickscreen Horizontal Slat Gate Systems - Page 20 – 23

Quickscreen Full Privacy System - Page 24 – 33

Quickscreen Sliding Gates - Page 34 – 37

V1.9

# QUICK SCREEN™

## The leading slat fencing system

## Designed & manufactured by Aluminum Outlet

## Save time & money

Quickscreen horizontal slat system fencing system provides you the most Premier slat system in the market. We have been supplying horizontal slat systems to the fencing and construction sector for over 15 years, so our system is proven and tested. Our range is designed with current architectural trends in mind providing that clean contemporary look.

Our 1", 2.56" and 6" slat systems are available to you for immediate delivery from our warehouses.

We offer an array of install options including.

1. 2.56" Post and side frame system. – easy assembly system with comprehensive installation options
2. Our new 4" post and side frame system designed to handle all types of extreme weather including wind loads up to 170 Mph or for that customer looking for a Bulkier look.
3. Our new Universal post system (one post does all) – Premium finish with slats inserting into the post providing a streamline finish.
4. Our original 1 way and 2 way. Premium finish same as Universal post just different posts for different applications.

Quickscreen Horizontal slat features and benefits

- Unique patented friction assembly, eliminating the need to use fixings to secure off the slats (quick assembly)
- Modular system which is easily width and height adjustable. Simply cut to suit opening.
- Array of install options to cover all types of applications.
- Proven system with over 15 years supplying to the market.
- Product engineered to meet all types of weather conditions.
- System provides privacy whilst still allowing airflow between slats.
- Complete system including gates and modular sliding gates options.
- Limited lifetime warranty

Why Quickscreen?

Due to our extensive experience with horizontal slat fencing we have perfected the system to provide you a slat system that is:

- Trial and tested to meet all types of applications and weather conditions.
- Very easy to assemble and install.
- Most importantly the business model has been perfected providing you a product with very healthy margins and return.

Call us for more information on our Reseller and Distributor business models.

## HIGHEST QUALITY FINISHES

Our range of genuine AAMA 2604 powder coat finishes has been carefully selected to include the most sought after colors on offer.

All components are suitably pre-treated prior to powder coating and are applied by fully accredited coating facilities.

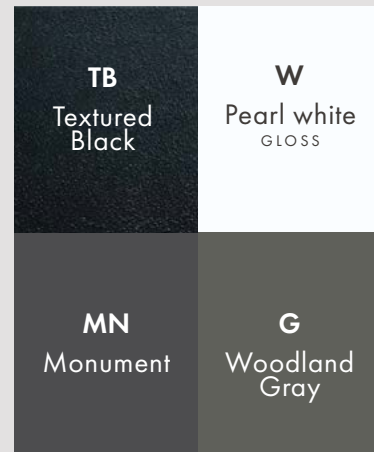

# QUICK SCREEN HORIZONTAL SLAT DESIGN OPTIONS



2.56" SLAT BETWEEN POSTS



1" SLAT BETWEEN POSTS

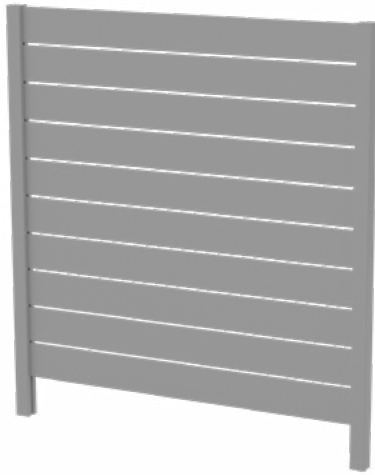

6" SLAT BETWEEN POSTS

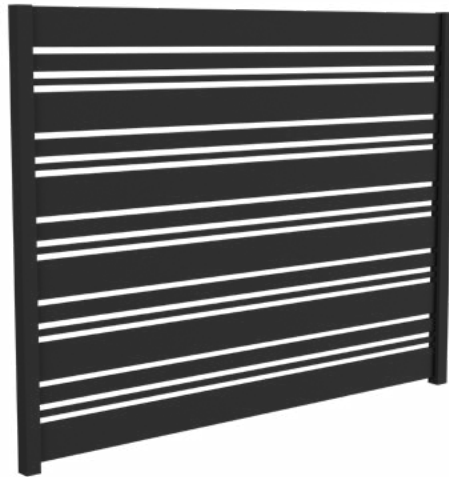

1", 2.56" & 6" COMBO SLAT BETWEEN POSTS

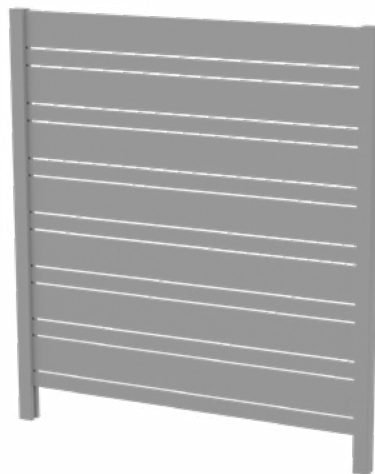

2.56" & 6" COMBO SLAT BETWEEN POSTS



2.56" & 6" COMBO SLAT BETWEEN PILLARS

## 1. NEW UNIVERSAL POST SYSTEM

1. QS-TP  
Universal post flat top plate (comes with post)

2. QSP-65HD 2413 3WAY  
Quickscreen Universal Post  
95" Long

3. QSP-SPACER-9-50PK  
Quickscreen 3/8"

- QSP-SPACER-12.7-50PK  
Quickscreen 1/2"

- QSP-SPACER-25.4"-50PK  
Quickscreen 1"

4. QS-SPACER-2413  
Snap in spacer/infill (23" spacer comes with all posts as starting spacer)  
95" length required for 1 way- start/end post and gate posts

5. XP-65BP-SETU  
4.5" x 4" Post Base Plate (w/ screws)

6. XP-65DC-2P  
Quickscreen 2PC Domical Cover

7. Quickscreen 1", 2.56" or 6" slat  
(refer QTY required page 4 and 7)

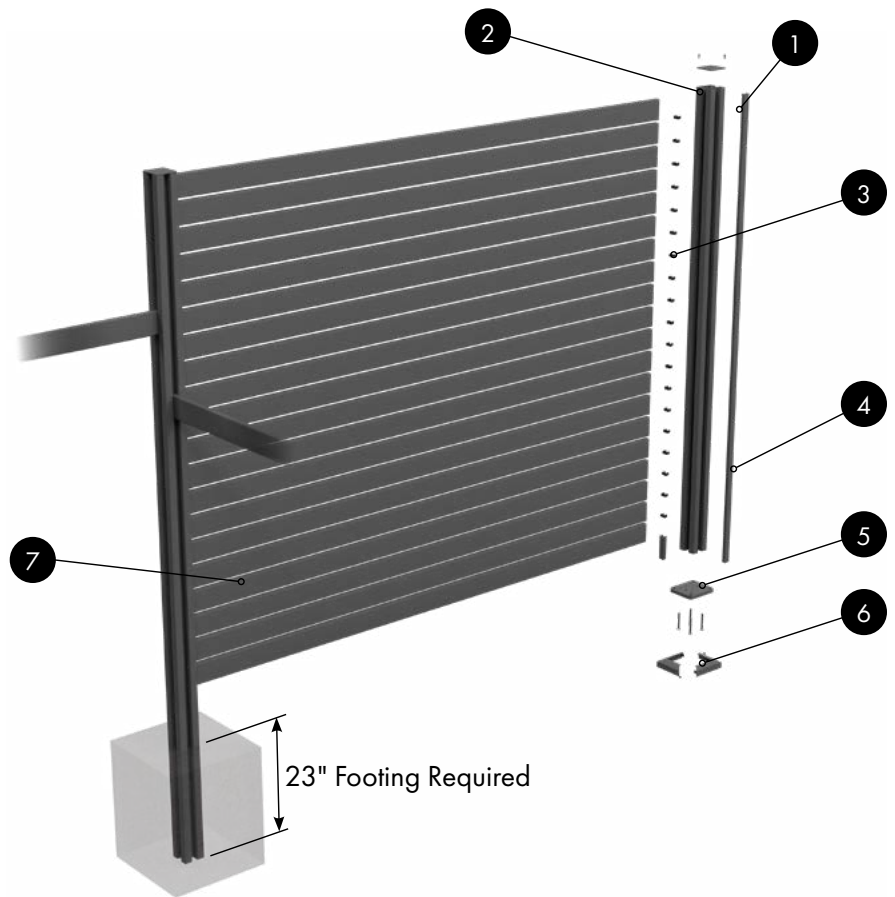

One post for corners, inline and ends as well as gate posts. (Need to also order QS-spacer-2413 for gate and end posts)

When is this install method good to use?

- Suitable install method for most fence application as premium finish and cost effective. Slats go into the post.



## 2. 65MM POST WITH SIDE FRAME

### 1. QS-EP-B-2PK

Side frame end plate (2 per bag, 2 bags required per side frame pack)

### 2. QSP-2400-SF-2PK OR QSP-1800-SF-2PK

Quickscreen side frame 95" OR 71" long - 2 Pack (QTY 1 pack per panel)

### 3. QSP-65HD 2413/2743/1828 FP

Quickscreen 2.56" HD Full Post 72", 95" or 108" Long

### 4. QSP-65HD-POSTEXT

Post Extender

### 5. Quickscreen 1", 2.56" or 6" slat

(refer QTY required page 4 and 6)

### 6. XP-65TP

Post flat top plate (QTY 1/post)

### 7. XP-1800-135

135° Side Frame

### 8. QSP-SPACER-9-50PK

Quickscreen 3/8"

### - QSP-SPACER-12.7-50PK

Quickscreen 1/2"

### - QSP-SPACER-25.4"-50PK

Quickscreen 1"

Aluminium snap in spacers, available in packs of 50.

### 9. XP-65BP-SETU

4.5" x 4" Post Base Plate (w/screws)

### 10. XP-65DC-2P

Quickscreen 2PC Domical Cover

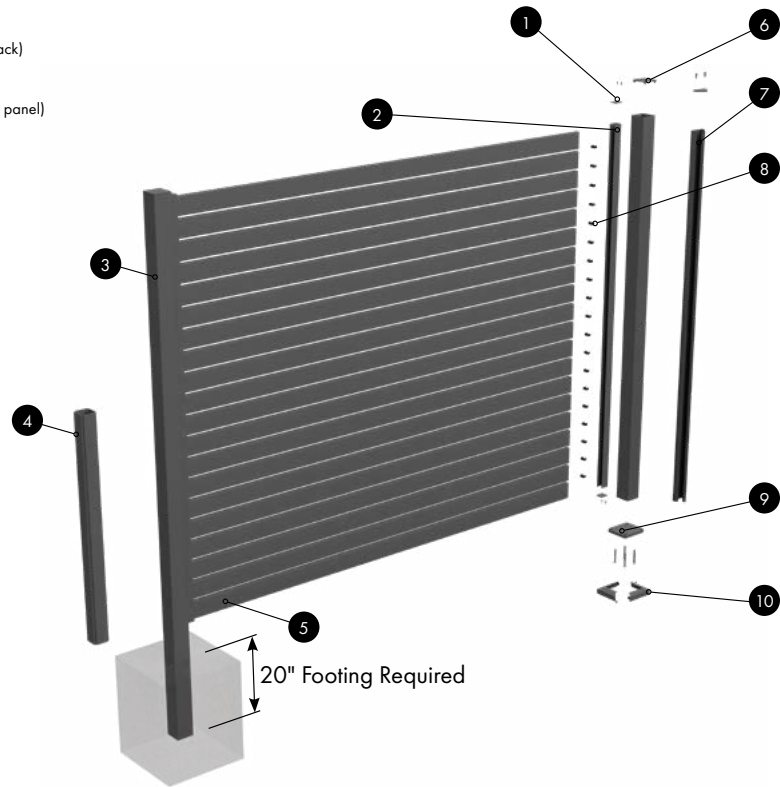

#### When is this install method good to use?

- When you have existing Pillars or posts to install fence between. Use between fence pillars or in patios & pergolas.
- Easiest install method when need to step the fence.
- When need fence panel higher than 6' high. Can make panel up to 95" high with combination of longer frame, full post, and post extension.
- Best system when you need the post to go 3' into the ground (frost line) for a fence 6' high. Also need post extension.
- When using the 135° adaptor to do a 45° corner.

## 3. NEW 4" SQUARE POST WITH HEAVY DUTY SIDE FRAME SYSTEM

### 1. QS-EP-B-2PK

Side frame end plate (comes with side frame)

### 2. QSP-2400-SF-2PK OR QSP-1800-SF-2PK

Quickscreen side frame 95" OR 71" long - 2 Pack (QTY 1 pack per panel)

### 3. QSP-100HD-2413 FP OR QSP-100HD-2743 FP

4"x4" Square Post  
95" & 108" long

### 4. Quickscreen 1", 2.56" or 6" slat

(refer QTY required page 4 and 6)

### 5. QSP-100HD-DC

4" Square raised dome cap (press fit)

### 6. QSP-SPACER-9-50PK

Quickscreen 3/8"

### - QSP-SPACER-12.7-50PK

Quickscreen 1/2"

### - QSP-SPACER-25.4"-50PK

Quickscreen 1"

Aluminium snap in spacers, available in packs of 50.

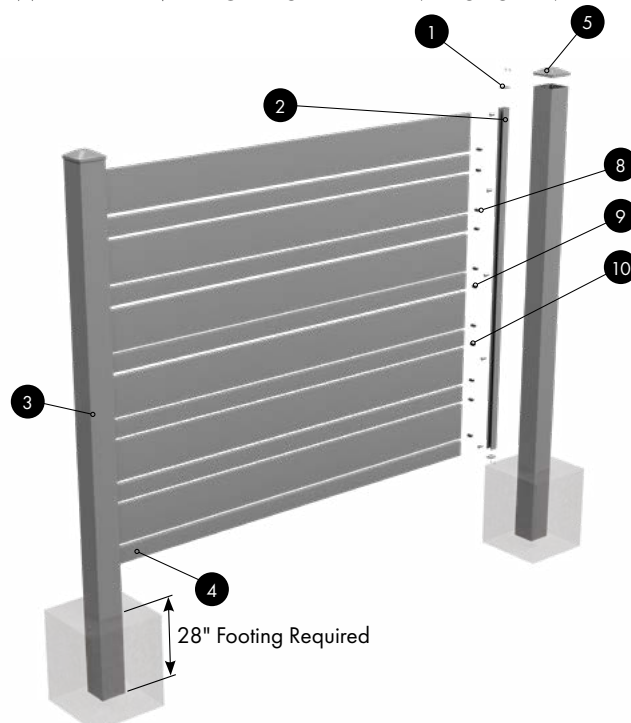

#### When is this install method good to use?

- This system has been specifically designed for area's where the fence needs to meet severe weather environments.
- Designed for fences that need to handle wind loads above 100 MPH.
- Has been designed to withstand Wind loads up to 170 MPH.
- Can also be used in all applications highlighted under standard side frame and post system



## QUICK SCREEN 1" SLAT

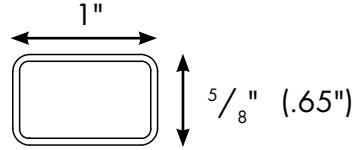

WALL THICKNESS:  $\frac{1}{16}$ " (.06")  
F\* $TU$  - 262MPa (.06" wall)

## QUICK SCREEN SLATS 1" WIDE x 71" LONG

ORDER CODE: QSP-2415SLAT

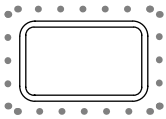

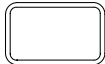
PROFILE	DESCRIPTION	LENGTH	QTY
	1" x .65" Slat	71"	1

SLAT PANEL HEIGHT	QTY REQUIRED QSP-SLAT (BASED ON 3/8" SPACING)
1' HIGH	9 - (12.00")
2' HIGH	18 - (23.9")
3' HIGH	27 - (36")
4' HIGH	36 - (46.8")
5' HIGH	45 - (60.3")
6' HIGH	54 - (72.5")
7' HIGH	63 - (84.275")
8' HIGH	73 - (96.5")

## QUICK SCREEN 2.56" STANDARD SLAT

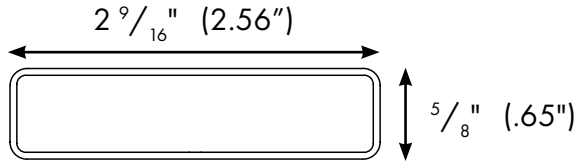

WALL THICKNESS:  $\frac{1}{16}$ " (.06")  
F\* $TU$  - 262MPa (.06" wall)

## QUICK SCREEN SLATS - 2 PACK

2.56" WIDE x 95" LONG

ORDER CODE: QSP-2415SLAT-2PK

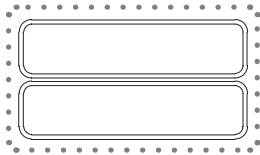

PROFILE	DESCRIPTION	LENGTH	QTY
	2.56" x .65" Slat	95"	2

## QUICK SCREEN™ SLATS - 2 PACK

2.56" WIDE x 71" LONG

ORDER CODE: QSP-1800SLAT-2PK

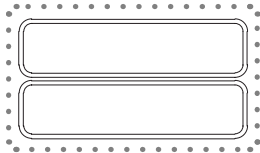

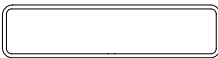
PROFILE	DESCRIPTION	LENGTH	QTY
	2.56" x .65" Slat	71"	2

SLAT PANEL HEIGHT	QTY REQUIRED QSP-SLAT-2PK (BASED ON 3/8" SPACING)
1' HIGH	2 - (11.4")
2' HIGH	4 - (23.1")
3' HIGH	6 - (34.85")
4' HIGH	8 - (46.5")
5' HIGH	10 - (58.3")
6' HIGH	12 - (70")
7' HIGH	14 - (81.75")
8' HIGH	16 - (93.5")

# QUICK SCREEN™ SLAT - 96" BOXED 72" HIGH

ORDER CODE: QSP-2415SLAT-PK

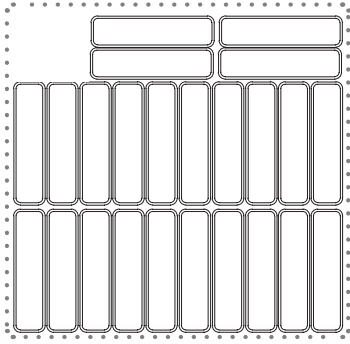

PROFILE	DESCRIPTION	LENGTH	QTY
	2.56" x .65" Slat	95"	24

PRODUCES A PANEL 96" WIDE x 71" HIGH (EXCLUDES POSTS)

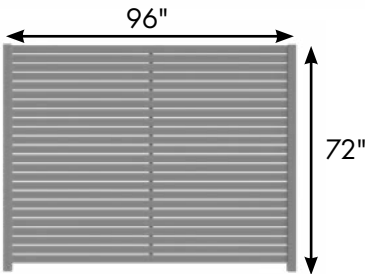
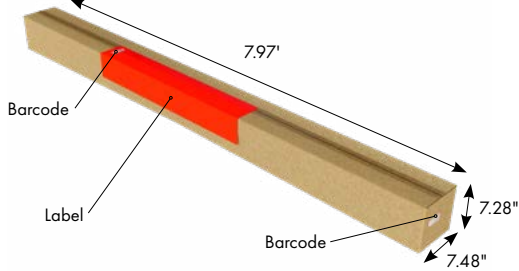

# QUICK SCREEN™ SLAT - 72" BOXED 72" HIGH

ORDER CODE: QSP-1800SLAT-PK

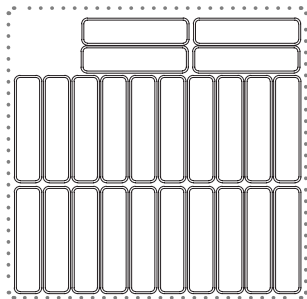

PROFILE	DESCRIPTION	LENGTH	QTY
	2.56" x .65" Slat	71"	24

72" WIDE x 72" HIGH (EXCLUDES POSTS)

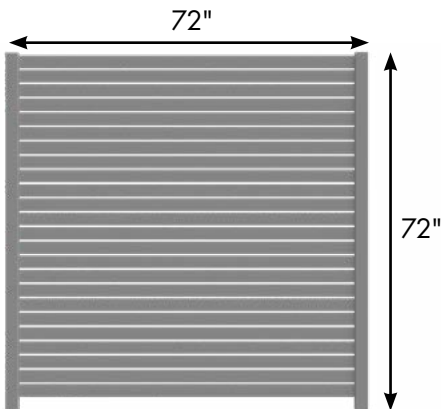

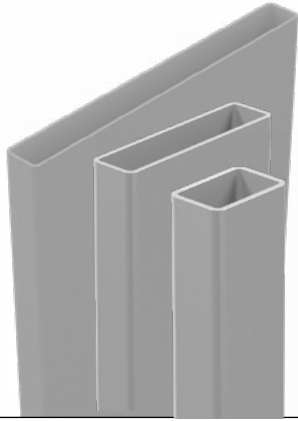

## QUICK SCREEN 6" SLAT

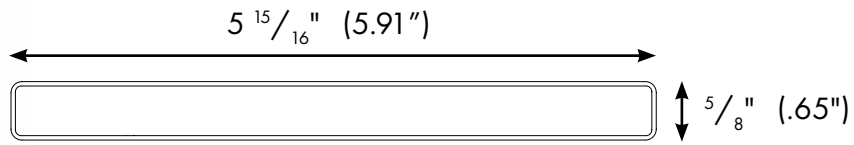

WALL THICKNESS:  $\frac{1}{16}$ " (.06")  
F\*<sub>TU</sub> - 262MPa (.08" wall)

## QUICK SCREEN SLATS - 2 PACK

5.91" WIDE x 95" LONG

ORDER CODE: QSP-150-2415-SLAT



PROFILE	DESCRIPTION	LENGTH	QTY
	5.91" x .65" Slat	95"	1

## QUICK SCREEN<sup>™</sup> SLATS - 2 PACK

5.91" WIDE x 71" LONG

ORDER CODE: QSP-150-1800-SLAT



PROFILE	DESCRIPTION	LENGTH	QTY
	5.91" x .65" Slat	71"	1

SLAT PANEL HEIGHT	QTY REQUIRED QSP-150-SLAT (BASED ON 1" SPACING)
1' HIGH	2 - (12.3")
2' HIGH	4 - (26.5")
3' HIGH	5 - (33.5")
4' HIGH	7 - (47.25")
5' HIGH	9 - (61")
6' HIGH	11 - (69")
7' HIGH	13 - (82")
8' HIGH	14 - (95.5")

# QUICK SCREEN™ 95" SIDE FRAME - 2 PACK

\* FULL POST, POST CAP AND SLATS NOT INCLUDED

ORDER CODE: QSP-2400-SF-2PK

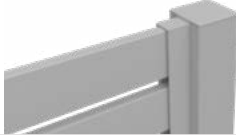
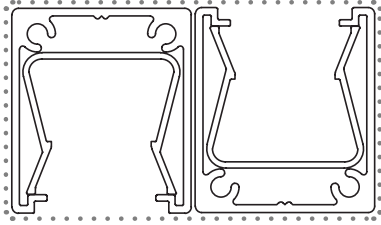

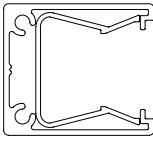
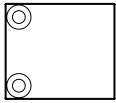
PROFILE	DESCRIPTION	LENGTH	QTY
	1.1" x 1.26" Side Frame	95"	2
	QSP-EP-2PK Side Frame End Cap	1.10" x 1.26"	2

# QUICK SCREEN™ 71" SIDE FRAME - 2 PACK

\* FULL POST, POST CAP AND SLATS NOT INCLUDED

ORDER CODE: QSP-1800-SF-2PK

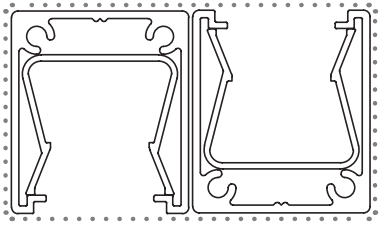

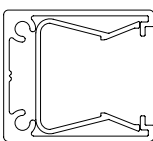
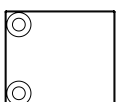
PROFILE	DESCRIPTION	LENGTH	QTY
	1.1" x 1.26" Side Frame	71"	2
	QSP-EP-2PK Side Frame End Cap	1.10" x 1.26"	2

# QUICK SCREEN™ SIDE FRAME CAP - 2 PACK

ORDER CODE: QSP-EP-2PK



PROFILE	DESCRIPTION	LENGTH	QTY
	QSP-EP-2PK	1.10" x 1.26"	2



**SCAN ME**  
**INSTALLATION**

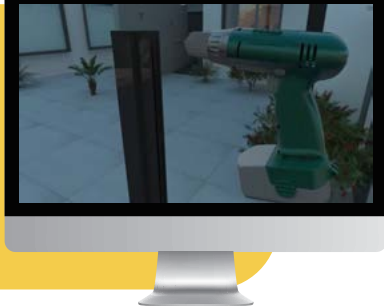

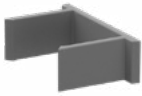

50 PACK

**Spacer blocks**

3/8" SPACERS

Order Code: QSP-SPACER-9-50PK

- Aluminum spacers
- Snaps into Quickscreen post
- Fast and easy install with post, slats and spacers

Powder coat colors —

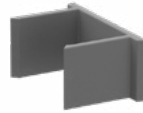

50 PACK

**Spacer blocks**

1/2" SPACERS

Order Code: QSP-SPACER-12.7-50PK

- Aluminum spacers
- Snaps into Quickscreen post
- Fast and easy install with post, slats and spacers

Powder coat colors —

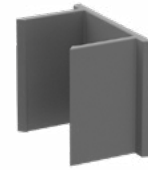

50 PACK

**Spacer blocks**

1" SPACERS

Order Code: QSP-SPACER-25.4-50PK

- Aluminum spacers
- Snaps into Quickscreen post
- Fast and easy install with post, slats and spacers

Powder coat colors —



**Quickscreen Post / Side Frame infill spacer 95"**

Order Code: QS-SPACER-2413

- Can use to modify post configuration
- Can be cut down for custom spacing or to fill gaps in on post.

Powder coat colors —



**2 9/16" x 2 9/16" heavy duty post**  
72", 95" & 108" LONG

Order Code: QSP-65HD 2413/2743 FP

Use with side frame. Includes top cap. XP-65-TP

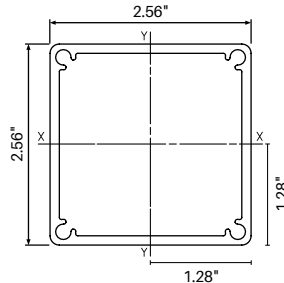

Powder coat colors —



**TECH SPECS**

- PP 255 / AP 255
- 2 9/16" x 2 9/16" larger profile, heavy duty post
- 0.125" wall thickness
- Screw flutes to screw on base plate if required
- Aluminum powder coated press-in top plate included with 8 foot posts
- bxx = 464.62 x 10E3 mmE4
- lyy = 464.62 x 10E3 mmE4

4x screw flutes in post allow tight fit of press in flat aluminum top plate.

Optional base plate can be attached using screw flutes for base plated post installations.

**4" Square Post**

72", 95" & 108" LONG

Order Code: QSP-65HD 2413/2743 FP

Use with side frame.



Powder coat colors —



**TECH SPECS**

- PP 255 / AP 255
- 2 9/16" x 2 9/16" larger profile, heavy duty post
- 0.125" wall thickness
- Screw flutes to screw on base plate if required
- Aluminum powder coated press-in top plate included with 8 foot posts
- bxx = 464.62 x 10E3 mmE4
- lyy = 464.62 x 10E3 mmE4

4x screw flutes in post allow tight fit of press in flat aluminum top plate.

Optional base plate can be attached using screw flutes for base plated post installations.



**2.56"x2.56" post flat top plate**  
POWDER COATED ALUMINUM

Order Code: **XP-65-TP**

- Alloy ADC12 aluminum plate - .12" thick
- Press into post screw flutes for secure fixing
- 8 foot posts come with free top plate included
- only purchases if extra top plates are required.

**Powder coat colors —**



**Two part domical cover**  
POWDER COATED ALUMINIUM

Order Code: **XP-65-DC-2P**

- Suits 2.56"x2.56" post with base plate
- 4.8"x4.17" outer - 2.64" x 2.64" inner
- Alloy ADC12
- Cover can be fitted to posts after fence is installed.

**Powder coat colors —**

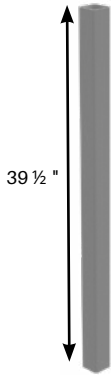

**Quickscreen Post Extender**

Aluminum

Order Code: **QSP-65HD-POSTEXT**

- 2.25" x 2.25" x 39 1/2 "
- Suits 2.56" x 2.56" Heavy Duty Post
- For use when posts need to go into ground more than 24" or fence higher than 6' (will also require side frame)

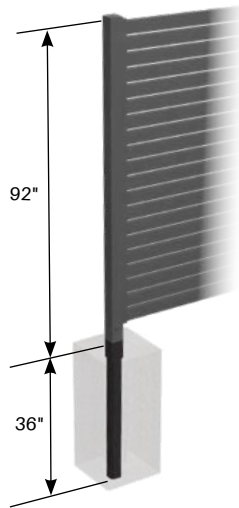

\*based on 95" post

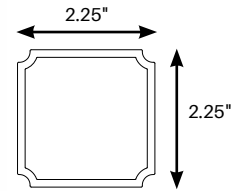
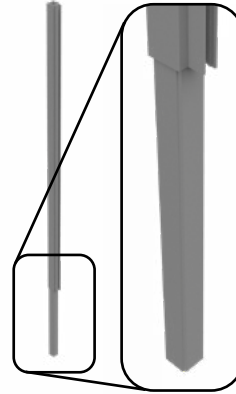

Images & drawings are not to scale





**Two part domical cover**  
**POWDER COATED ALUMINIUM**  
 Order Code: **XP-65-DC-2P**

- Suits 2.56"x2.56" post with base plate
- 4.8"x4.17" outer - 2.64" x 2.64" inner
- Alloy ADC12
- Cover can be fitted to posts after fence is installed.

**Powder coat colors —**



**50 PACK**  
**Spacer blocks**  
 $\frac{3}{8}$ " SPACERS  
 Order Code: **QSP-SPACER-9-50PK**

- Aluminum spacers
- Snaps into Quickscreen post
- Fast and easy install with post, slats and spacers

**Powder coat colors —**



**50 PACK**  
**Spacer blocks**  
 $\frac{1}{2}$ " SPACERS  
 Order Code: **QSP-SPACER-12.7-50PK**

- Aluminum spacers
- Snaps into Quickscreen post
- Fast and easy install with post, slats and spacers

**Powder coat colors —**

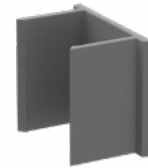

**50 PACK**  
**Spacer blocks**  
 1" SPACERS  
 Order Code: **QSP-SPACER-25.4-50PK**

- Aluminum spacers
- Snaps into Quickscreen post
- Fast and easy install with post, slats and spacers

**Powder coat colors —**



**Quickscreen Post / Side Frame infill spacer 95"**  
 Order Code: **QS-SPACER-2413**

- Can use to modify post configuration
- Can be cut down for custom spacing or to fill gaps in on post.

**Powder coat colors —**

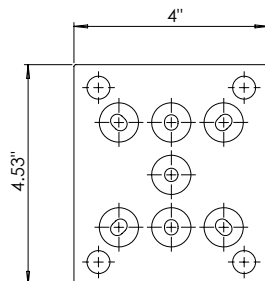
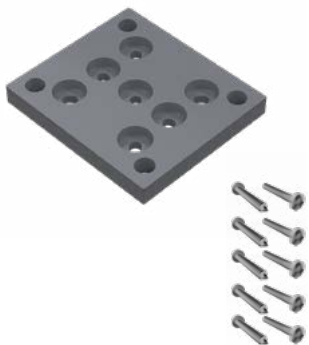

**Universal post base plate set**  
 1x base plate & screws. Suits 2.56" posts.  
**POWDER COATED Aluminum**  
 Order Code: **XP-65BP-SETU**

- 4.53"x4" base plate (.5" thick) with fixing holes
- Simply screw base plate into post screw flutes
- 12G screws included in set

**Powder coat colors —**

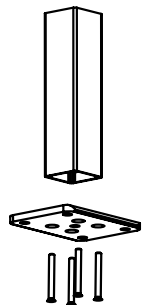



# QUICK SCREEN POSTS - 1 WAY POSTS BOXED

AVAILABLE JULY 2026

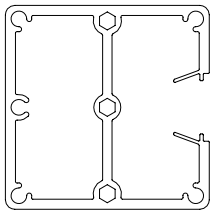
ORDER CODE: QSP-65HD-2413-3WAY

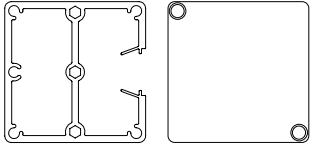

PROFILE	DESCRIPTION	LENGTH	QTY
	2.56" x 2.56" 1 Way Post with post cap and screws	95"	1
	Post Insert	24"	1



Powder coat colors —

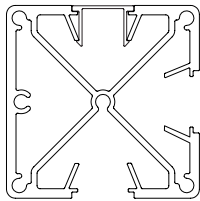

# QUICK SCREEN™ UNIVERSAL POST

ORDER CODE: QSP-65HD-2413-3WAY

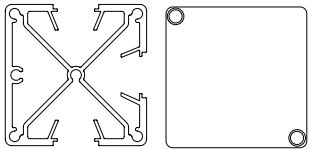

PROFILE	DESCRIPTION	LENGTH	QTY
	2.56" x 2.56" Universal Post with post cap and screws	95"	1
	Post Insert	24"	2
	Post Insert	95"	2

Powder coat colors —





**Post flat top plate**  
 POWDER COATED ALUMINUM  
 Order Code: **XP-65-TP**  
 • Alloy ADC12 aluminum plate - .12" thick  
 • Press into post screw flutes for secure fixing

Powder coat colors —

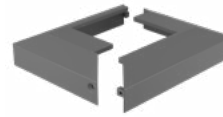

**Two part domical cover**  
 POWDER COATED Aluminum  
 Order Code: **XP-65-DC-2P**

- Suits 2.56"x2.56" post with base plate
- 4.8"x4.17" outer - 2.64" x 2.64" inner
- Alloy ADC12
- Cover can be fitted to posts after fence is installed.

Powder coat colors —

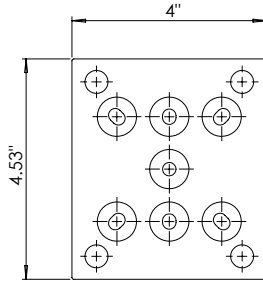
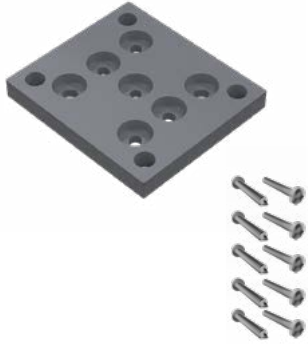

**Universal Post base plate set (suits full post, 1 way, 2 way and universal post)**

1x base plate & screws  
 POWDER COATED Aluminum  
 Order Code: **XP-65BP-SET**

- 4.53"x4" base plate (.5" thick) with fixing holes
- Simply screw base plate into post screw flutes
- 12G screws included in set

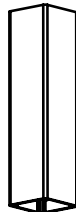

Powder coat colors —

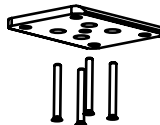

**Quickscreen Post / Side Frame infill spacer 95"**

- Order Code: **QS-SPACER-2413**
- Can use to modify post configuration
  - Can be cut down for custom spacing or to fill gaps in on post.

Powder coat colors —



**50 PACK**  
**Spacer blocks**  
 3/8" SPACERS

Order Code: **QSP-SPACER-9-50PK**

- Aluminum spacers
- Snaps into Quickscreen post
- Fast and easy install with post, slats and spacers

Powder coat colors —



**50 PACK**  
**Spacer blocks**  
 1/2" SPACERS

Order Code: **QSP-SPACER-12.7-50PK**

- Aluminum spacers
- Snaps into Quickscreen post
- Fast and easy install with post, slats and spacers

Powder coat colors —

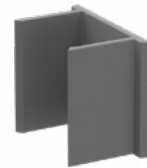

**50 PACK**  
**Spacer blocks**  
 1" SPACERS

Order Code: **QSP-SPACER-25.4-50PK**

- Aluminum spacers
- Snaps into Quickscreen post
- Fast and easy install with post, slats and spacers

Powder coat colors —



# ACCESSORIES & ADDITIONAL INSTALL OPTIONS



**2 PART Center SUPPORT RAIL**

Insert side frames and infill before center support rail

## Center support rail

71" LONG  
Order Code: XP-1800-CSR

**OPTIONAL EXTRA**  
Commonly used for screens 6' or wider to provide strength & rigidity to panel  
Snap-on cover hides fixings - provides slimline sturdy support rail with no visible fixings

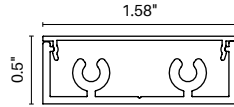

Powder coat colors —

**TB**

## TECH SPECS

- PP 126 / AP 188
- Alloy 6063-T5
- Screw fix center support rail to each slat
- Includes 2x screw flutes for press-in top cap
- Top cap sold separately
- bxx = 1.73 x 10E3 mmE4
- lyy = 26.34 x 10E3 mmE4

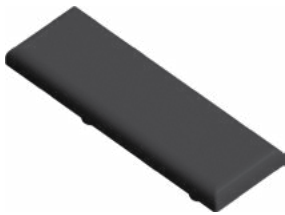
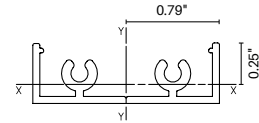

## Center Support Rail Cap

3MM THICK

- Order Code: XP-CSRC-B
- Black nylon cap
  - Simply press into screw flutes in center support rail
  - Easy and fast fitting of cap

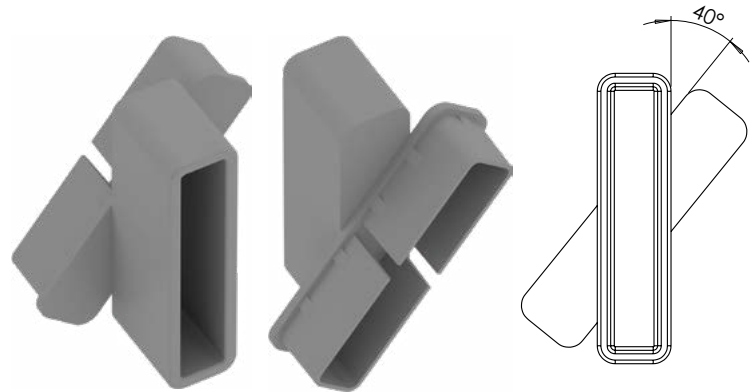

## Louvre brackets

1 x LEFT & 1 x RIGHT  
Order Code: QS-LB

**40° FINAL SLAT ANGLE**

- 1 x left and 1 x right bracket per pack.
- Die cast aluminum
- Suits 2.56" x .65" slat - Press brackets onto end of slat then insert bracket into side frame
- Cost effective and fast way to achieve a fixed louvre finish

## 10 PACK Slat locking clip

- Order Code: XPL-SLATCLIP-10PK
- Aluminium cast locking clip with SS304 self tapping screws
  - Optional extra for install. Acts as a mechanical fix to prevent chance of side frames splaying open. Consider if installing side frames to timber posts which may move/twist OR if side frames installed onto aluminum posts for large fence runs - generally not required for side frame installs to pillars.
  - Hidden under side frame end plate.

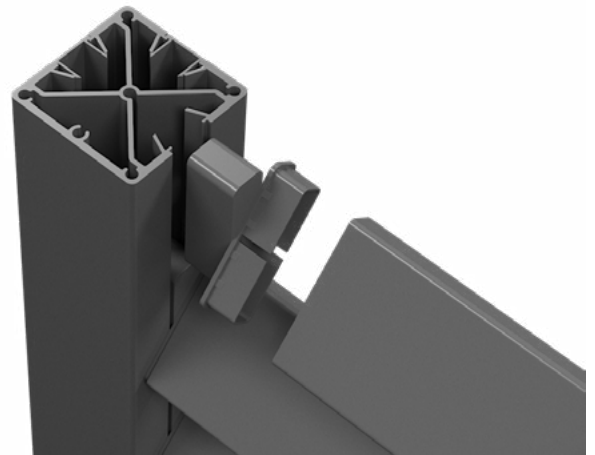
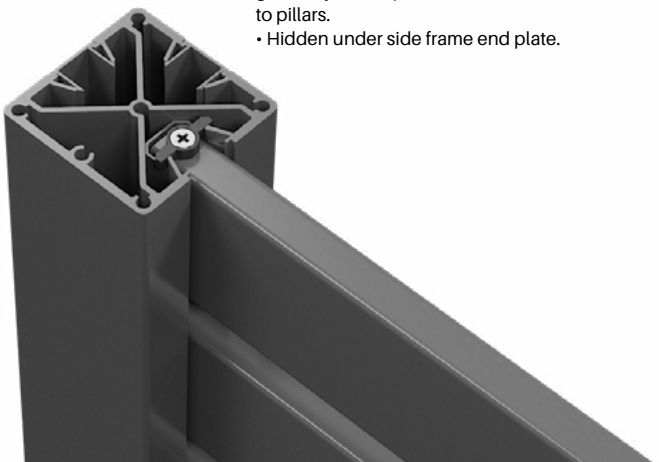

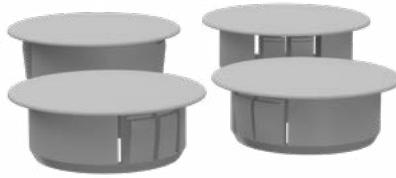

4 PACK

**Black or White finish**

Order Code: SS-POSTPLUG-4PK

SS-POSTPLUG-4PK-W

- 1.25"mm outer top suits .98" hole
- Suits post wall thickness .125"
- Cap holes in posts when fixing posts to structures



### Angle Adapter

Order Code: QS-1828-135

- Allows for install of slat at a 35° to 55° angle
- Fit to 2.56 " or 4" post

Powder coat colors —



### Angle Adapter Top Plate

Order Code: QSP-135-EP-2PK

- Require 1 x set per angle adapter

Powder coat colors —



*Images & drawings are not to scale*



# QUICK SCREEN™ HORIZONTAL GATES

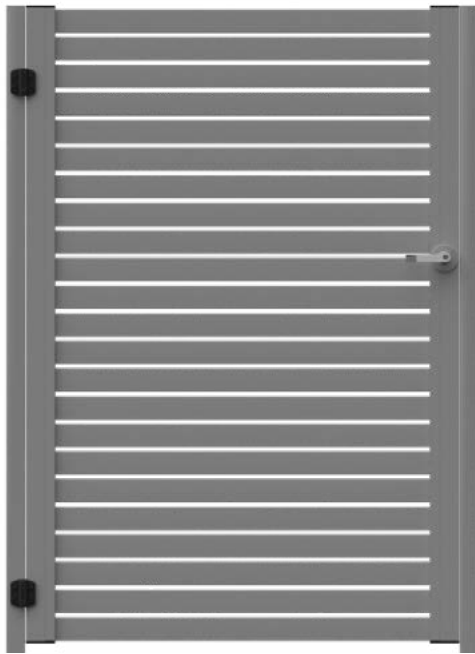

2.56" SLAT  
PEDESTRIAN GATE

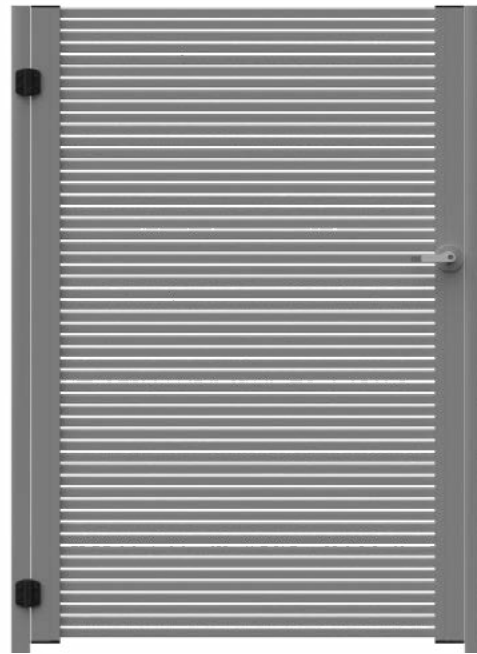

1" SLAT  
PEDESTRIAN GATE



6" SLAT  
PEDESTRIAN GATE



PEDESTRIAN GATE  
FULL PRIVACY



PEDESTRIAN GATE  
COMBO SLAT

## NEW HEAVY DUTY GATE FRAME SYSTEM

### 1. QSP-HDGF-KIT

Quickscreen Heavy Duty Gate Frame Kit

### 2. QSP-HDGATE-1828/2413-FR

Quickscreen Heavy Duty Gate Frame  
72" or 95" Long

### 3. QSP-SPACER-9-50PK

Quickscreen 3/8"

### - QSP-SPACER-12.7-50PK

Quickscreen 1/2"

### - QSP-SPACER-25.4"-50PK

Quickscreen 1"

Aluminium snap in spacers, available in packs of 50.

### 4. Quickscreen 1", 2.56" or 6" slat

### 5. SS-TS-50-SS034

Hex Head SS304 Screws

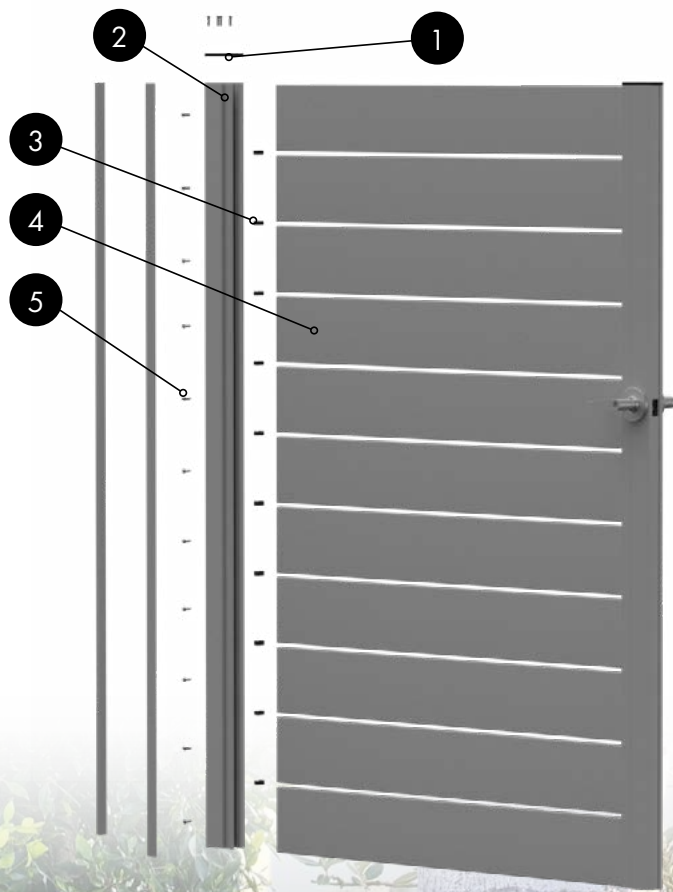

# QUICK SCREEN HEAVY DUTY GATE FRAME

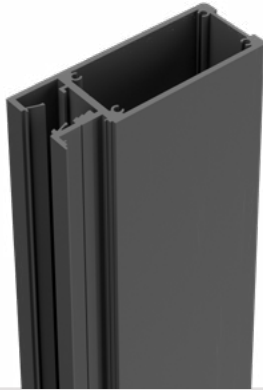
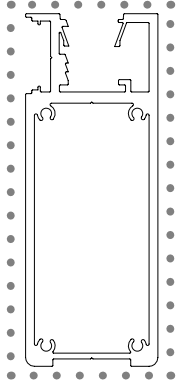

## Heavy Duty Gate Frame

71" long

Order Code: QSP-HDGATE-1828-FR

- PP 534 / AP534
- .125" wall thickness with .2" center web
- .125" radius corners

Powder coat colors —

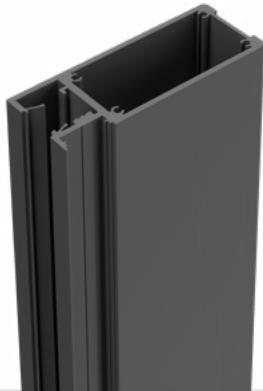
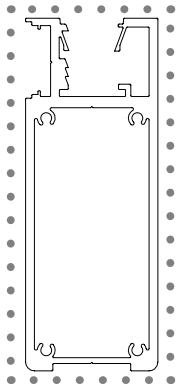

## Heavy Duty Gate Frame

95" long

Order Code: QSP-HDGATE-2413-FR

- PP 534 / AP534
- .125" wall thickness with .2" center web
- .125" radius corners

Powder coat colors —

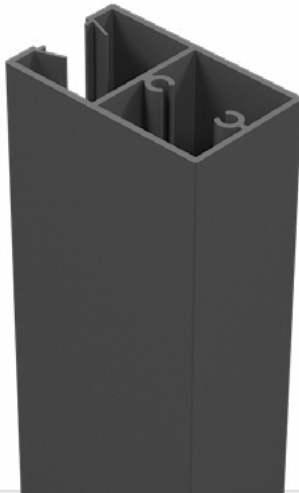

## Quickscreen Heavy Duty Top and Bottom Rail

84" long

Order Code: QSP-HDGATE-TBRAIL-2134

- Two required per gate

Powder coat colors —



NEW - AVAILABLE APRIL 2026

## Rail Bracket 4 Pack

Order Code: QSP-GFR-BRAC-4PK

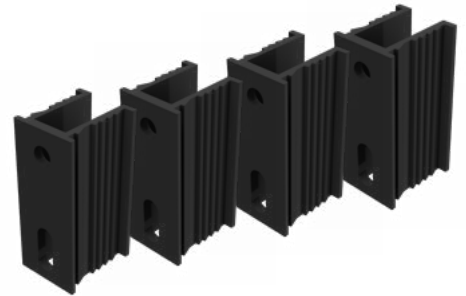

## Heavy duty gate frame cap (2 pack)

Metal End Plate

Order Code: QSP-HDGFC-2PK

- Includes 4 x plates & 18 screws



## 50pk Self drilling screw

SS304

Order Code: SS-TS-50-SS304



**50 PACK**  
**Spacer blocks**  
**3/8" SPACERS**

Order Code: **QSP-SPACER-9-50PK**

- Aluminum spacers
- Snaps into Quickscreen post
- Fast and easy install with post, slats and spacers

**Powder coat colors —**



**50 PACK**  
**Spacer blocks**  
**1/2" SPACERS**

Order Code: **QSP-SPACER-12.7-50PK**

- Aluminum spacers
- Snaps into Quickscreen post
- Fast and easy install with post, slats and spacers

**Powder coat colors —**



**50 PACK**  
**Spacer blocks**  
**1" SPACERS**

Order Code: **QSP-SPACER-25.4-50PK**

- Aluminum spacers
- Snaps into Quickscreen post
- Fast and easy install with post, slats and spacers

**Powder coat colors —**



## GATE HARDWARE & ACCESSORIES

**0.75"**  
gap spacing

**1**  
alignment leg

One alignment leg on hinge allows for quick and sturdy fixing on one side with flexible positioning on the other side

- D&D patented tension adjustment
- Strong, moulded polymer and stainless steel
- Adjust tension from both ends of the hinge
- No visible fixings
- Decorative trim covers available in black finish
- Super strong engineering polymers and stainless steel components
- Won't rust, bind, sag or stain
- Limited lifetime warranty
- Pool fencing compliant - Rated for **gates up to 150lbs**

**D** **TRU**Close® **HEAVY DUTY**

**TruClose® hinge pair**  
**Heavy duty**

**1 ALIGNMENT LEG**

D&D code: TCHD1AS3BT

Order Code: TC-H-AT-HD-B



**0.59" - 1.57"**  
gap spacing

**KEYED TO DIFFER**

- Lockable from both sides of gate
- Locks are keyed to alike
- Rekeyable, 6-pin security lock
- Fits up to 6" deep posts
- Black polymer

**D** **LOKK**Latch® **DELUXE**

**Lokk Latch® deluxe**

D&D code: LL3PWA

Order Code: LL-DL



**D&D Gate Stop**  
**Black Polymer Finish**  
Order Code: **SS-GS**

- Ideal gate alignment device
- Prevents damage to latches & hinges
- Great reduces gate slam noise
- Tough, durable polymer + rubber bumper



**D&D Padlockable Drop Bolt**  
**Black Finish**

Order Code: **QB124**

- Powder coated black, stainless steel drop-bolt
- Padlockable (\*Padlock not included)
- Tough, moulded polymer mounting system

- 1. QSP-HDGF-KIT  
Quickscreen Heavy Duty Gate Frame Kit
- 2. QSP-HDGATE-1828/2413-FR  
Quickscreen Heavy Duty Gate Frame  
72" or 95" Long
- 3. Quickscreen 1", 2.56" 6" or full  
privacy slat
- 4. Heavy Duty Top and Bottom Rail
- 5. SS-TS-50-SS034  
Hex Head SS304 Screws
- 6. Heavy Duty Bracket  
4pk with dome head screws
- 7. QSP-SPACER-9-50PK  
Quickscreen 3/8"
- QSP-SPACER-12.7-50PK  
Quickscreen 1/2"
- QSP-SPACER-25.4"-50PK  
Quickscreen 1"  
Aluminium snap in spacers, available in packs of  
50.

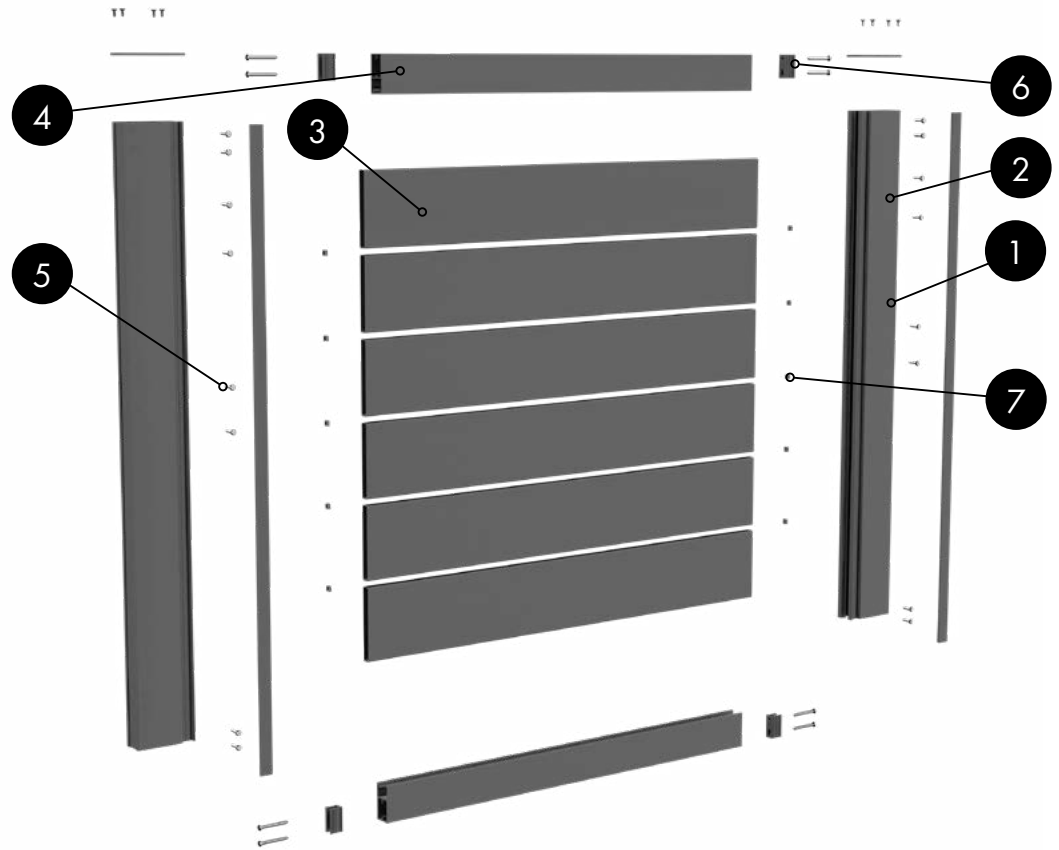

Images & drawings are not to scale

### Premium Soft Close Hinge

Black or White Finish

Order Code: QSG-PSC750



- Soft Closing Mechanism - Prevents Gate slamming and ensures smooth, silent closing
- Fully adjustable - up and down as well as in and out
- Up to 150 degree opening
- Ideal for Pedestrian gates with 1pr of hinge capable load 25-125lbs

Available colors —

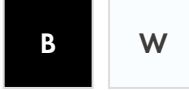

# QUICK SCREEN™ HEAVY DUTY GATE FRAME

QSP-HDGATE-SET



# QUICK SCREEN

## FULL PRIVACY SYSTEM

We are excited to offer this new system as an attractive alternative to current full privacy systems in the market. Our core goal with this product was to provide a full privacy fencing system with all the benefits of aluminum at a price that makes it available to a greater section of the market.

We achieve this with a slimline T&G board that we have designed to be very strong whilst light weight. Our T&G board uses a combination of intelligent extrusion design and structural grade alloys to achieve this. We further compliment the system through the adaption of our patented friction fit technology to provide a framing system that is very quick to assemble on site.

As a business opportunity all the numbers stack up well considering the possible market penetration this product has due to its price point.

For more information on distribution of this product please call.



### HIGHEST QUALITY FINISHES

Our range of genuine AAMA 2604 powder coat finishes has been carefully selected to include the most sought after colors on offer.

All components are suitably pre-treated prior to powder coating and are applied by fully accredited coating facilities.

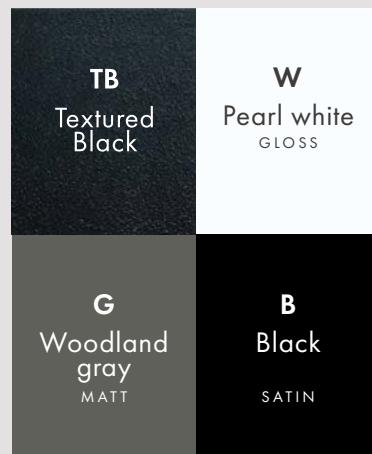

# FULL PRIVACY BOARD

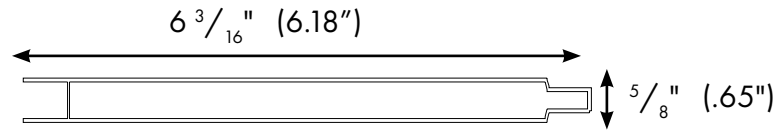

WALL THICKNESS: 1/16" (.05")

F\**TU* - 262MPa (.06" wall)

5 <sup>15</sup>/<sub>16</sub>" (5.91") Coverage



# QUICK SCREEN FULL PRIVACY PANELS

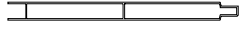

PROFILE	DESCRIPTION	LENGTH	QTY
	QFP-1804TGB	71"	1

**Quickscreen Full Privacy T & G Board - 6" x 5/8" @ 71" long**

Order Code: QFP-1804TGB



PROFILE	DESCRIPTION	LENGTH	QTY
	QFP-1804TGB	95"	1

**Quickscreen Full Privacy T & G Board - 6" x 5/8" @ 95" long**

Order Code: QFP-2415TGB

# QUICK SCREEN FULL PRIVACY SYSTEM

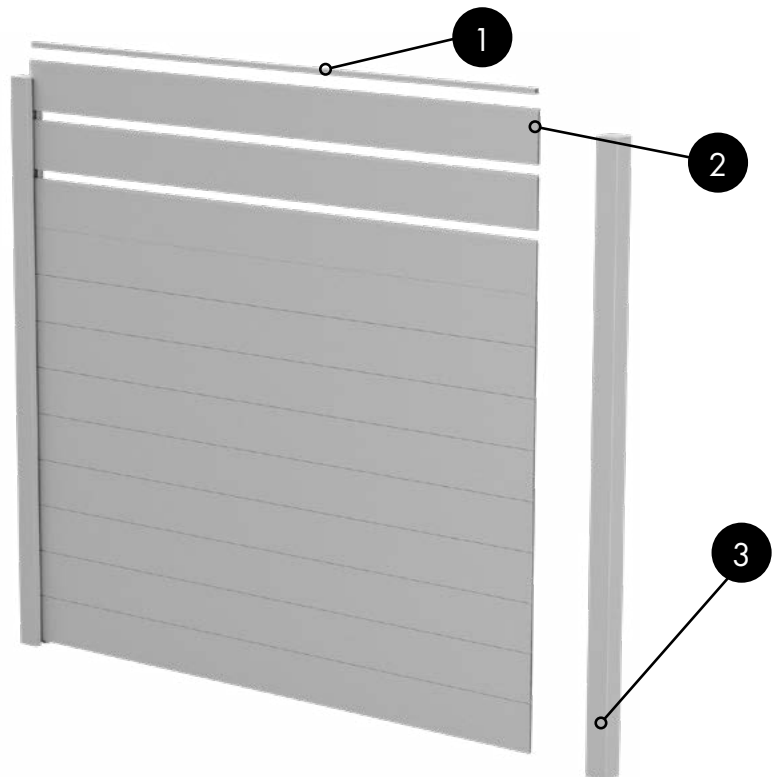

- 1. Quickscreen Full Privacy Horizontal Capping Rail
- 2. Quickscreen Full Privacy T&G Board
- 3. 1 Way, 2 Way, or Universal Posts



### Quickscreen Full Privacy Horizontal Capping Rail

71" & 95" long

Order Code: QFP-150-1804FPHC / QFP-150-2415FPHC



### Quickscreen Post / Side Frame infill spacer 95"

Order Code: QS-SPACER-2413

- Can use to modify post configuration
- Can be cut down for custom spacing or to fill gaps in on post.

Powder coat colors —



*Images & drawings are not to scale*





*Images & drawings are not to scale*

# QUICK SCREEN POSTS - 1 WAY POSTS BOXED

AVAILABLE JULY 2026

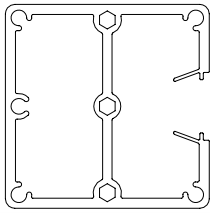
ORDER CODE: QSP-65HD-2413-3WAY

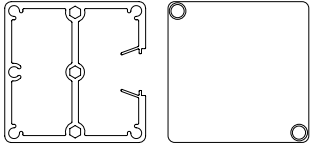

PROFILE	DESCRIPTION	LENGTH	QTY
	2.56" x 2.56" 1 Way Post with post cap and screws	95"	1
	Post Insert	24"	1



Powder coat colors —

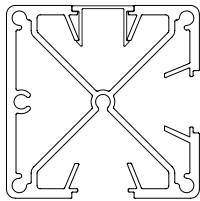

# QUICK SCREEN™ UNIVERSAL POST

ORDER CODE: QSP-65HD-2413-3WAY

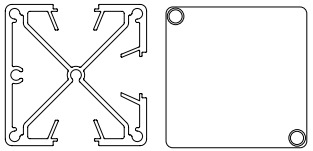

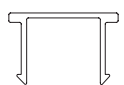
PROFILE	DESCRIPTION	LENGTH	QTY
	2.56" x 2.56" Universal Post with post cap and screws	95"	1
	Post Insert	24"	2
	Post Insert	95"	2

Powder coat colors —



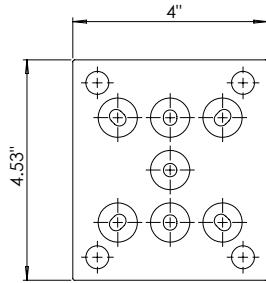
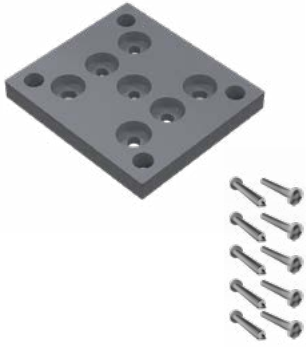

**Universal post base plate set**

1x base plate & screws

POWDER COATED Aluminum

Order Code: XP-65BP-SETU

- 4.53"x4" base plate (.5" thick) with fixing holes
- Simply screw base plate into post screw flutes
- 12G screws included in set

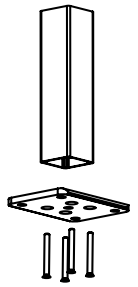

**Powder coat colors —**



**Two part domical cover**

POWDER COATED ALUMINIUM

Order Code: XP-65-DC-2P

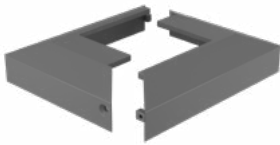

- Suits 2.56"x2.56" post with base plate
- 4.8"x4.17" outer - 2.64"x 2.64" inner
- Alloy ADC12
- Cover can be fitted to posts after fence is installed.

**Powder coat colors —**



**Post flat top plate**

POWDER COATED ALUMINIUM

Order Code: XP-65-TP



- Alloy ADC12 aluminum plate - .12" thick
- Press into post screw flutes for secure fixing

**Powder coat colors —**



**SCAN ME  
INSTALLATION**



- 1. QSP-HDGF-KIT  
Quickscreen Heavy Duty Gate Frame Kit
- 2. QSP-HDGATE-1828/2413-FR  
Quickscreen Heavy Duty Gate Frame  
72" or 95" Long
- 3. Quickscreen 1", 2.56" 6" or full  
privacy slat
- 4. Heavy Duty Top and Bottom Rail
- 5. SS-TS-50-SS034  
Hex Head SS304 Screws
- 6. Heavy Duty Bracket  
4pk with dome head screws

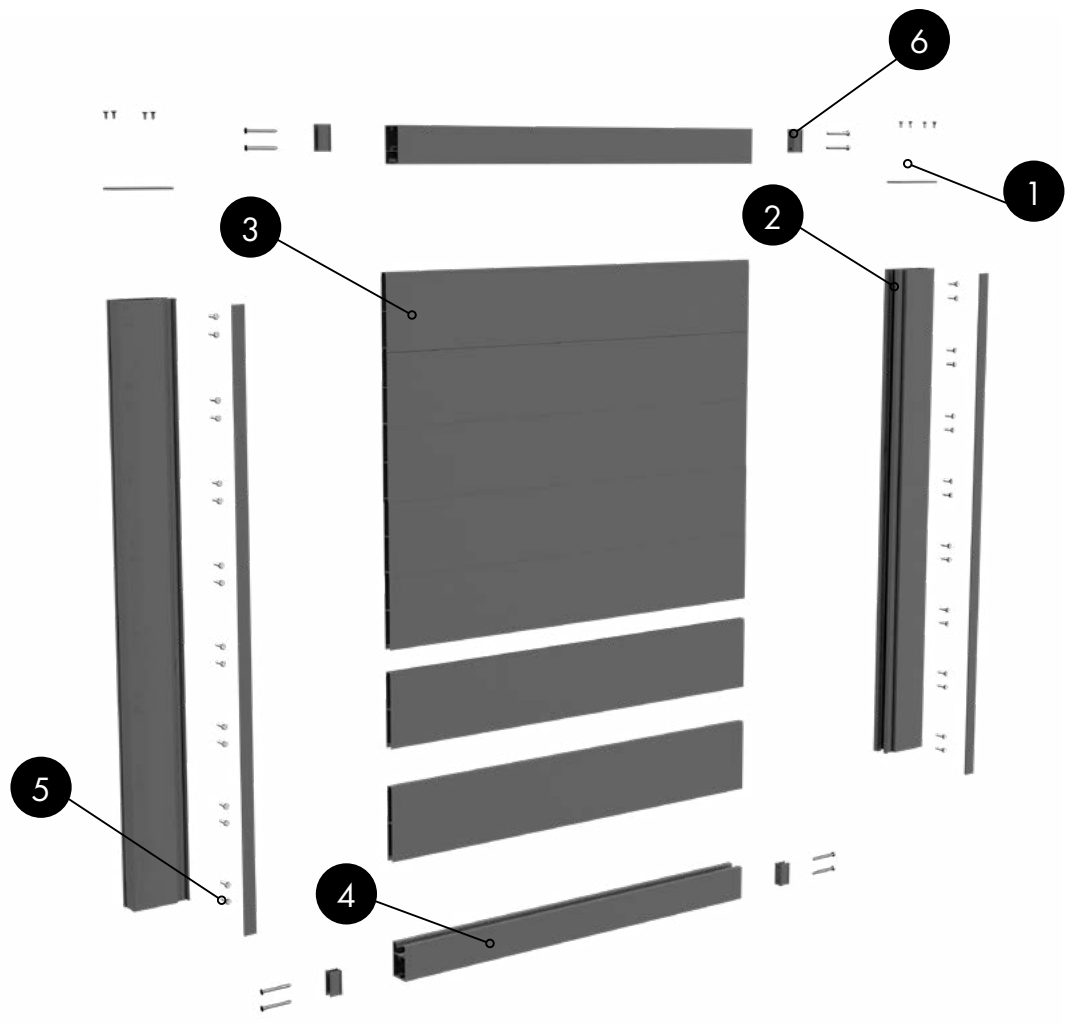

- 1. Quickscreen Full Privacy Horizontal Top and Bottom  
Capping Rail
- 2. Quickscreen Heavy Duty Gate Frame  
(Qty 2 per gate)
- 3. Quickscreen Heavy Duty Gate Frame Cap 2 Pack (1 per  
frame, 2 per gate)
- 4. 6" Full Privacy T&G Board.
- 5. Quickscreen HD gate frame screws 50pk

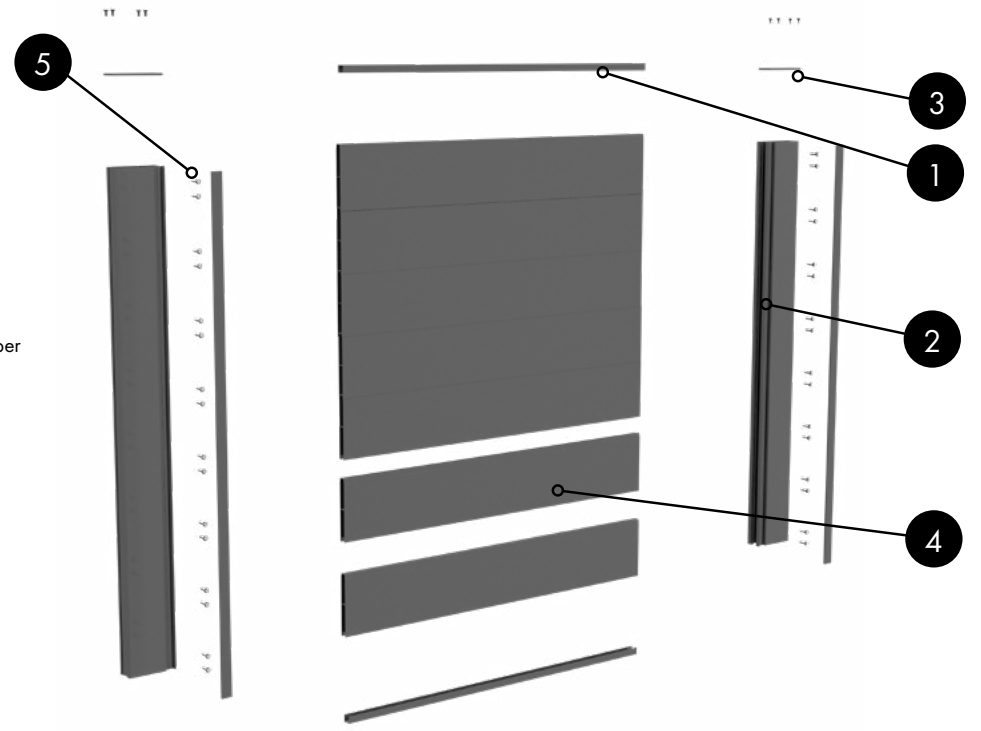

# QUICK SCREEN HORIZONTAL FULL PRIVACY SYSTEM

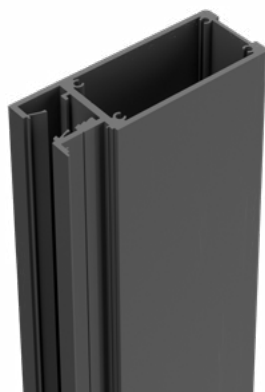
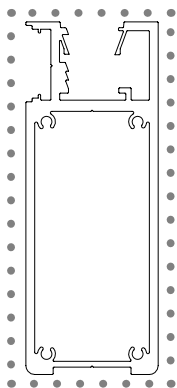

## Heavy Duty Gate Frame

71" long

Order Code: QSP-HDGATE-1828-FR

- PP 534 / AP534
- .125" wall thickness with .2" center web
- .125" radius corners

Powder coat colors —

MN

G

W

TB

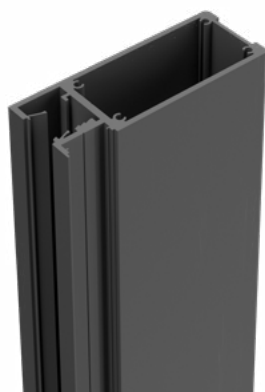
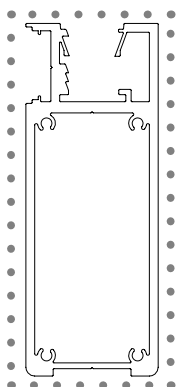

## Heavy Duty Gate Frame

95" long

Order Code: QSP-HDGATE-2413-FR

- PP 534 / AP534
- .125" wall thickness with .2" center web
- .125" radius corners

Powder coat colors —

MN

G

W

TB

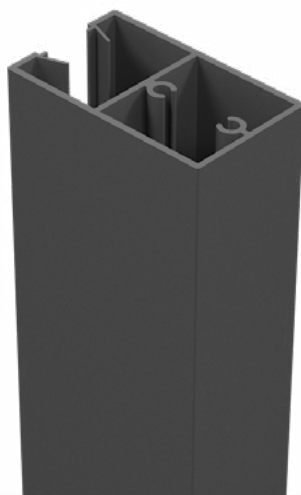

## Quickscreen Heavy Duty Top and Bottom Rail

84" long

Order Code: QSP-HDGATE-TBRAIL-2134

- Two required per gate

Powder coat colors —

MN

G

W

TB

## Rail Bracket 4 Pack

Order Code: QSP-GFR-BRAC-4PK

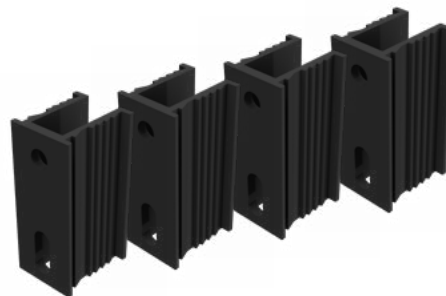

## Heavy duty gate frame cap (2 pack)

Metal End Plate

Order Code: QSP-HDGFC-2PK

- Includes 4 x plates & 18 screws



## 50pk Self drilling screw

SS304

Order Code: SS-TS-50-SS304



**Quickscreen Full Privacy Horizontal Capping Rail**

71" & 95" long

Order Code: QFP-150-1804FPHC / QFP-150-2415FPHC



# GATE HARDWARE & ACCESSORIES

**0.75"**  
gap spacing

**1**  
alignment leg

One alignment leg on hinge allows for quick and sturdy fixing on one side with flexible positioning on the other side

- D&D patented tension adjustment
- Strong, moulded polymer and stainless steel
- Adjust tension from both ends of the hinge
- No visible fixings
- Decorative trim covers available in black finish
- Super strong engineering polymers and stainless steel components
- Won't rust, bind, sag or stain
- Limited lifetime warranty
- Pool fencing compliant - Rated for **gates up to 150lbs**

**D<sup>®</sup> TRUClose<sup>®</sup> HEAVY DUTY**

## TruClose<sup>®</sup> hinge pair Heavy duty

1 ALIGNMENT LEG

D&D code: TCHD1AS3BT

Order Code: TC-H-AT-HD-B



**0.59" - 1.57"**  
gap spacing

KEYED TO DIFFER

- Lockable from both sides of gate
- Locks are keyed alike
- Rekeyable, 6-pin security lock
- Fits up to 6" deep posts
- Black polymer

**D<sup>®</sup> LOKKLatch<sup>®</sup> DELUXE**

## Lokk Latch<sup>®</sup> deluxe

D&D code: LL3PWA

Order Code: LL-DL



## Premium Soft Close Hinge Black or White Finish

Order Code: QSG-PSC750



- Soft Closing Mechanism - Prevents Gate slamming and ensures smooth, silent closing
- Fully adjustable - up and down as well as in and out
- Up to 150 degree opening
- Ideal for Pedestrian gates with 1pr of hinge capable load 25-125lbs

Available colors —



# QUICK SCREEN SLIDING GATE OPTIONS

## SELECT FROM A RANGE OF SLIDING GATE OPTIONS

You can now make an array of sliding gate designs using our new heavy duty gate frame and vertical top and bottom rail system. This is achieved by creating multiple gate modules and then connecting them to each other using the gate frame as a joiner/midrail.

Save time and money without requirement of fully fabricating and welding.

Contact us for detailed assembly instructions.

### Horizontal slat sliding gate.

2.56" or 6" slats or combination  
with 3/8", 1/2" or 1" slat spacing.

Patented 'no weld' gate side frames for fast assembly.

### Full privacy horizontal gate.

2.56" or 6" slats or combination.

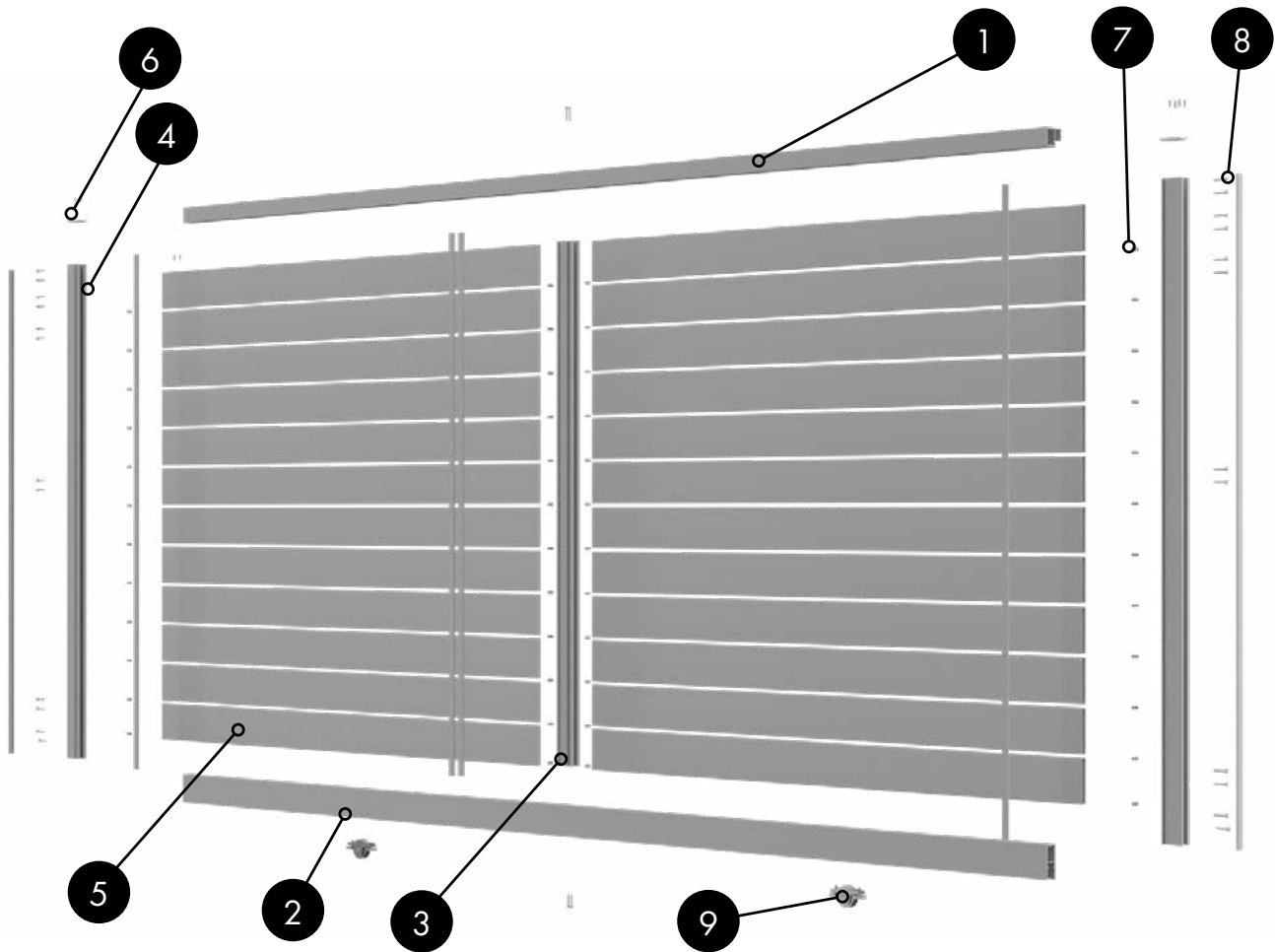

1

**Sliding gate top rail**  
19' long  
Order Code: XPSG-5800-TR

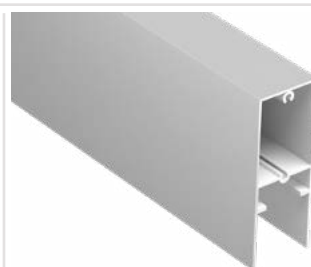

2

**Sliding gate bottom rail**  
19' long  
Order Code: XPSG-5800-BR

3



### Heavy Duty Mid Rail

Order Code: QSSG-MIDRAIL-2248

Used to join multiple panels together to create sliding gate - also used in horizontal application to create multiple designs

4



### Heavy Duty Gate Frame

71" long and 95" long

Order Code: QSP-HDGATE-1828-FR

- PP 534 / AP534
- .125" wall thickness with .2" center web
- .125" radius corners

35

5

### 1", 2.56", 6" or full privacy slat

Refer page 4, 6 or 44

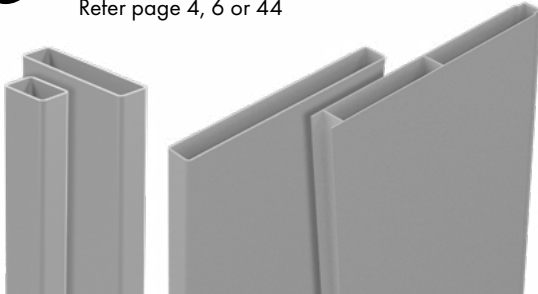

### Heavy duty gate frame cap (4 pack)

Metal End Plate

Order Code: QSP-HDGF-KIT

- Includes 4 x plates & 18 screws

6

Powder coat colors —



7



50 PACK

### Spacer blocks

3/8" / 1/2" / 1" SPACERS

Order Code:

QSP-SPACER-9-50PK

QSP-SPACER-12.7-50PK

QSP-SPACER-25.4-50PK



### Quickscreen infill spacer 95"

Order Code:

QS-SPACER-2413

8



PACK OF 16

### Gate frame screws

12Gx2.56" HEX

FLANGE HEAD

Order Code:

XP-SCREWSGF-16PK

9



### Sliding gate wheel

Order Code: XPSG-WHEEL



### Sliding gate wheel clamping set

Order Code: QSSG-WHEEL-CS

Required for clamping wheels to sliding gate bottom rail.



### Steel sliding gate track

3000mm long or 6000mm long

Order Code:

XPSG-3000-TRACK-ST

XPSG-6000-TRACK-ST



### Roller guide

Order Code: QSSG-ROLLER

# QUICK SCREEN MODULAR SLIDING GATE

IDEAL SYSTEM AS PROVIDES FOR EASY SHIPPING ALL ACCROSS THE USA AS CAN BE MADE IN 6" OR 8' MODULES  
 SELECT FROM A RANGE OF SLIDING GATE OPTIONS

You can now make an array of sliding gate designs using our new heavy duty gate frame and vertical top and bottom rail system. This is achieved by creating multiple gate modules and then connecting them to each other using the gate frame as a joiner/midrail.

Save time and money without requirement of fully fabricating and welding.

Contact us for detailed assembly instructions.

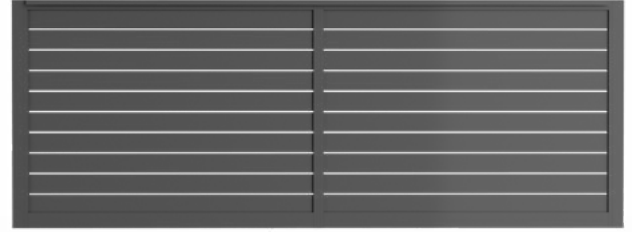

### Horizontal slat sliding gate.

1", 2.56", 6" or Full Privacy slats or combination with 3/8", 1/2" or 1" slat spacing.

Patented 'no weld' gate side frames for fast assembly.

### Full privacy horizontal gate.

6" T&G Board

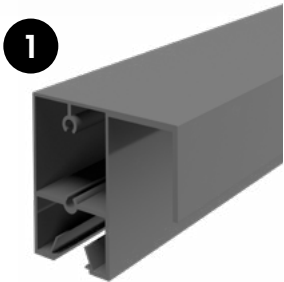
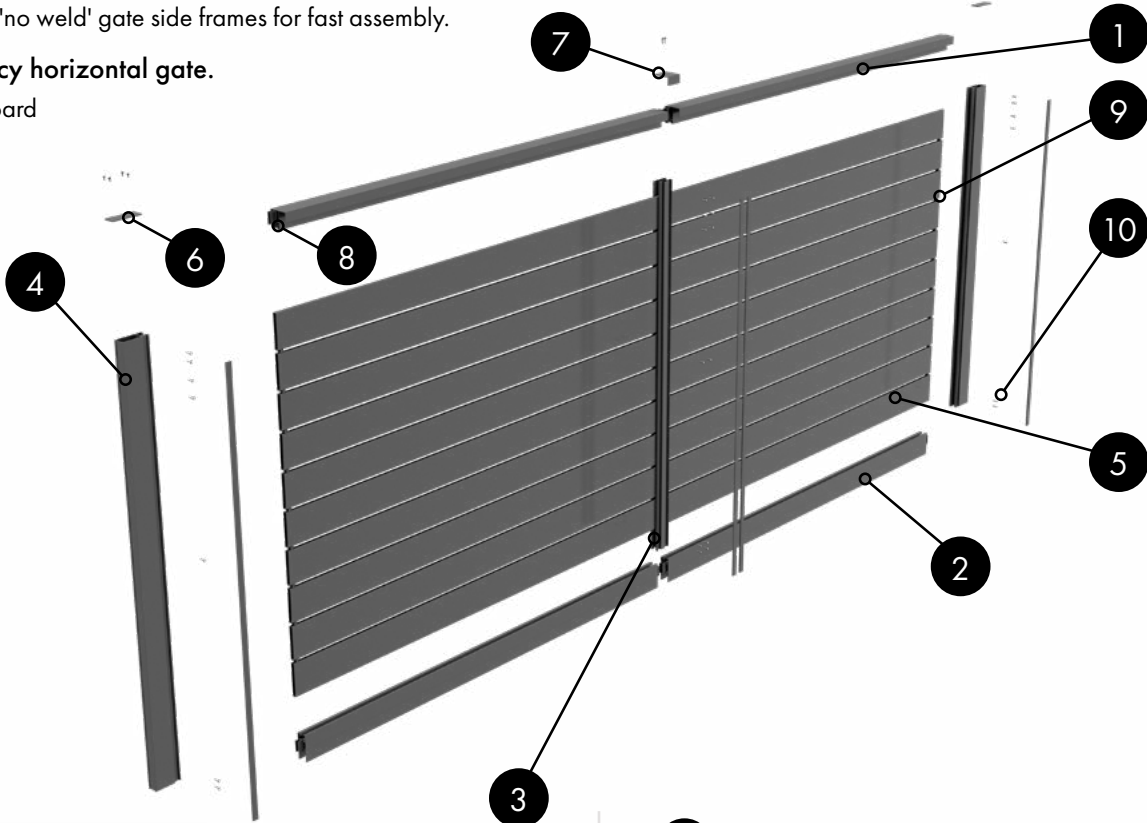

**1**  
**Sliding gate top rail**  
 71" or 95" long  
 Order Code: QSSG-1828/2413-TR

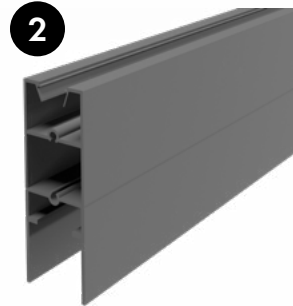

**2**  
**Sliding gate bottom rail**  
 71" or 95" long  
 Order Code: QSSG-1828/2413-BR

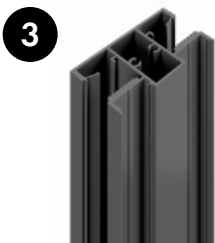

**3**  
**Heavy Duty Mid Rail**  
 Order Code: QSSG-MIDRAIL-2248  
 Used to join multiple panels together to create sliding gate - also used in horizontal application to create multiple designs



**4**  
**Heavy Duty Gate Frame**  
 71" long  
 Order Code: QSP-HDGATE-1828-FR  
 • PP 534 / AP534  
 • .125" wall thickness with .2" center web  
 • .125" radius corners



**5** 1", 2.56", 6" or Full Privacy slat  
Refer page 4, 6 or 44

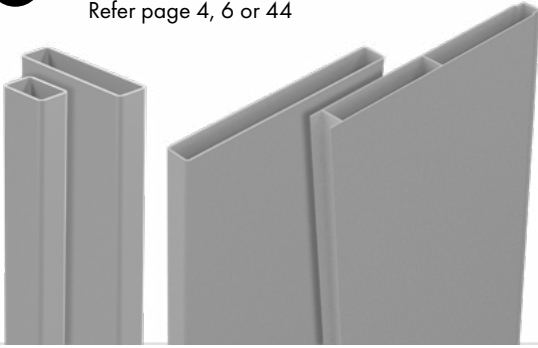

**6** Heavy duty gate frame cap (4 pack)  
Metal End Plate  
Order Code: QSP-HDGF-KIT  
Includes 4 x plates & 16 screws

Powder coat colors —



**7** End Plate  
Order Code: QSSG-TR-EP

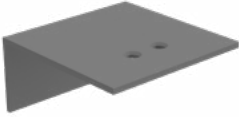

**8** HD Top & Bottom Rail Bracket 4PK  
Order Code: QSP-GFR-BRAC-4PK



**9** 50 PACK  
Spacer blocks  
3/8" SPACERS  
Order Code:  
QSP-SPACER-9-50PK



50 PACK  
Spacer blocks  
1/2" SPACERS  
Order Code:  
QSP-SPACER-12.7-50PK



50 PACK  
Spacer blocks  
1" SPACERS  
Order Code:  
QSP-SPACER-25.4-50PK

Quickscreen infill spacer 95"  
Order Code:  
QS-SPACER-2413



**10** PACK OF 16  
Gate frame screws  
12Gx2.56" HEX  
FLANGE HEAD  
Order Code:  
XP-SCREWSGF-16PK



Sliding gate wheel clamping set  
Order Code: QSSG-WHEEL-CS  
Required for clamping wheels to sliding gate bottom rail.



Sliding gate wheel  
Order Code: XPSG-WHEEL



Steel sliding gate track  
3000mm long or 6000mm  
long  
Order Code:  
XPSG-3000-TRACK-ST  
XPSG-6000-TRACK-ST



Roller guide  
Order Code: QSSG-ROLLER

